

KENWOOD

HF TRANSCEIVER

TS-440S

INSTRUCTION MANUAL

KENWOOD CORPORATION

Thank you for purchasing the new TS-440S transceiver. Please read this instruction manual carefully before placing your transceiver in service. This unit has been carefully engineered and manufactured to rigid quality standards, and should give you satisfactory and dependable operation for many years.

This Instruction Manual covers the TS-440S, with and without AT (Automatic Antenna Tuner) unit. When there are differences in operation, separate instructions will be given for each model. Illustrations show the TS-440S with AT unit.

The following explicit definitions apply in this manual:

- Note:** If disregarded, inconvenience only, no risk of equipment damage or personal injury.
- Caution:** Equipment damage may occur, but not personal injury.

CONTENTS

1. FEATURES	3	4. CIRCUIT DESCRIPTION	20
2. INSTALLATION	4	4-1. GENERAL DESCRIPTION	20
2-1. PRECAUTIONS	4	4-2. TRANSMITTER SECTION	20
2-2. FIXED STATION	4	4-3. RECEIVER SECTION	20
2-2-1. Interconnection	4	4-4. CIRCUIT BOARD DESCRIPTION	20
2-2-2. Grounding	4	4-4-1. RF unit (X44-1680-00)	20
2-2-3. Antenna	5	4-4-2. IF unit (X60-1300-00)	20
2-2-4. Key connection	5	4-4-3. Control unit (X53-1450-00)	20
2-3. MOBILE	5	4-4-4. PLL unit (X50-2050-00)	20
2-3-1. Mounting bracket installation	5	4-4-5. Final unit (X45-1470-00)	20
2-3-2. Power supply connection	5	4-4-6. Filter unit (X51-1340-00)	20
3. OPERATION	6	4-4-7. AT (Automatic Antenna Tuner) unit (X57-1150-00)	20
3-1. OPERATING CONTROLS	6	5. MAINTENANCE AND ADJUSTMENT	21
3-1-1. Front panel	6	5-1. GENERAL INFORMATION	21
3-1-2. Rear panel	10	5-2. SERVICE	21
3-1-3. Top cover	11	5-3. CLEANING	21
3-2. RECEIVE	12	5-4. IN CASE OF DIFFICULTY	21
3-2-1. Initial setting	12	5-5. MICROPROCESSOR BACK-UP LITHIUM BATTERY	22
3-2-2. CW zero-beat operation	12	5-6. MICROPROCESSOR RESET	22
3-2-3. Direct keyboard frequency entry	13	5-7. ORDERING SPARE PARTS	22
3-2-4. AM reception	13	5-8. ADJUSTMENTS	23
3-3. TRANSMIT	13	5-8-1. Cover removal	23
3-3-1. SSB (LSB, USB) mode	13	5-8-2. Internal views	23
3-3-2. CW mode	14	5-8-3. Digital display calibration	24
(a) Semi-automatic break-in	14	5-8-4. Optional 10 Hz display resolution	24
(b) Full-automatic break-in	14	5-8-5. CW zero beat frequency selection	24
3-3-3. FM mode	14	5-8-6. Side tone level	25
* Subaudible tone	15	5-8-7. Beep tone selection	25
3-3-4. AM mode	15	5-8-8. Beep tone level	25
3-4. AUTOMATIC ANTENNA TUNER	15	5-8-9. Tuning dial torque	26
3-5. DUAL DIGITAL VFO's	15	5-8-10. Linear amplifier control	26
3-5-1. Why two VFO's	15	6. OPTIONAL ACCESSORIES	27
3-5-2. Split frequency	15	6-1. CRYSTAL FILTER INSTALLATION	27
(a) A=B switch	15	6-2. VOICE SYNTHESIZER UNIT VS-1 INSTALLATION	28
(b) A/B switch	15	6-3. INTERFACE IC KIT IC-10 INSTALLATION	29
(c) SPLIT switch	15	6-4. OTHER ACCESSORIES	30
(d) T-F SET switch	15	7. BLOCK DIAGRAM	33
3-6. MEMORY	16	8. SCHEMATIC DIAGRAM	34
3-6-1. Memory entry	16	9. SPECIFICATIONS AND ACCESSORIES	41
3-6-2. Transferring memory information to the VFO	16	9-1. SPECIFICATIONS	41
3-6-3. Transferring data between memory channels	17	9-2. ACCESSORIES	42
3-6-4. Entering/Transferring data in the split frequency channels	17	10. REFERENCE	43
3-6-5. Clearing a memory channel	17	10-1. ANTENNA INSTALLATION	43
3-6-6. Memory recall	17	10-1-1. Fixed station	43
3-7. SCAN	17	10-1-2. Mobile	43
3-7-1. Memory scan	17	10-2. MOBILE OPERATION	44
3-7-2. Program scan	18	10-2-1. Installation	44
3-7-3. Scan speed	18	10-2-2. Noise reduction	45
3-7-4. Memory channel lockout	18	10-2-3. Battery capacity	45
3-8. AFSK	19	10-3. RADIO FREQUENCY ALLOCATION	46
3-8-1. Reception	19		
3-8-2. Transmit	19		
3-8-3. AMTOR operation	19		
3-9. OPERATION WITH A LINEAR AMPLIFIER	19		

1. FEATURES

1. Wide dynamic range

New advances in circuit design have made a 102 dB dynamic range (500 Hz IF bandwidth) possible.

2. General coverage reception from 100 kHz to 30 MHz

In addition to transmission and reception on all amateur bands from 1.8 to 28 MHz, the TS-440S provides a continuous tuning general coverage receiver with a range of 100 kHz to 30 MHz.

3. Automatic antenna tuner

The optional, built-in automatic antenna tuner will operate from 3.5 to 28 MHz.

4. All-mode operation

USB, LSB, CW, AM, FM, and AFSK modes are provided.

5. 100% continuous duty transmit

Transmission at a 100% duty cycle is possible for relatively long durations (one hour or less) in any mode, including FM and AFSK.

6. CW full break-in

Full break-in operation is possible in the CW mode. Rapid transmit/receive switching also makes the radio suitable for data communications in the SSB mode, such as AMTOR.

7. Build-in XIT

XIT (Transmitter incremental tuning) allows fine tuning of the transmitter frequency.

8. Switchable IF bandwidth

The IF bandswitch allows you to tailor the receiver bandwidth to the operating conditions. Several selections are provided; AUTO, W (Wide), M1 (Medium 1), M2 (Medium 2) and N (Narrow). When the AUTO position has been selected the radio will select the optimum bandwidth for the selected mode of operation.

9. Switchable AGC time constant

A switch is provided to select either FAST or SLOW AGC action.

10. All mode squelch

11. Built-in RF power/SWR meter

12. Versatile frequency control

- Accurate frequency selection is possible due to the use of a single reference oscillator circuit.
- Continuous tuning of all frequencies thru the use of digital VFO technology. The basic 10 Hz step tuning rate is modified, according to the selected mode, for optimum tuning speed and accuracy. An automatic fast scan function is also provided.
- Dual, digital VFO's (A/B) enable crossband, cross mode operation.
- 100-channel memory (including 10 odd-split channels) stores the frequency, band, and mode.
- Memory scan and two programmable scan ranges.
- Direct entry of the desired frequency using the front panel numeric keypad is also possible.
- A memory scroll function allows review of the memory channel contents.
- Selection of the desired memory channel is possible using either the TUNING dial or microphone UP/DOWN pushbuttons.
- The T-F SET function is useful for split frequency operation.
- An optional tone unit TU-8 may be used in conjunction with the odd-split memory channels to allow 10 meter repeater operations with CTCSS access.
- Optional computer interface.
- Built-in long-life memory back-up battery.
- 2-color fluorescent display tube indicates frequency and other operational data.

13. Front panel control of the TUNING dial torque is provided.

2. INSTALLATION

2-1. PRECAUTION

1. Avoid direct sunlight, and select a dry, well ventilated location.
2. Since the heat sink is on the rear panel, avoid placing the equipment with the bottom and rear sides close to a wall or desk.
3. When installing the equipment in an automobile, ensure adequate ventilation. Install the equipment in

a location where the rear does not make direct contact with the seat, and is not directly exposed to vibration.

4. Avoid installing the equipment in front of the car heater air outlet.
5. The standard operating voltage of the equipment is 13.8 V. Do not operate below 12 V or over 16 V.

2-2. FIXED STATION

2-2-1. Interconnection

The TS-440S requires more than 18A at 13.8 VDC when transmitting at full power. Use the PS-50 or PS-430 power supply for fixed stations.

Note:

The PS-50 base station supply is needed for continuous transmission operation.

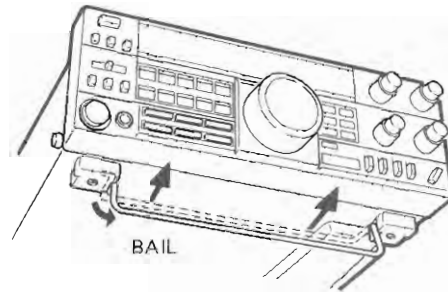

The transceiver can be elevated for operating convenience.

Caution:

Do not use the bail to carry the transceiver.

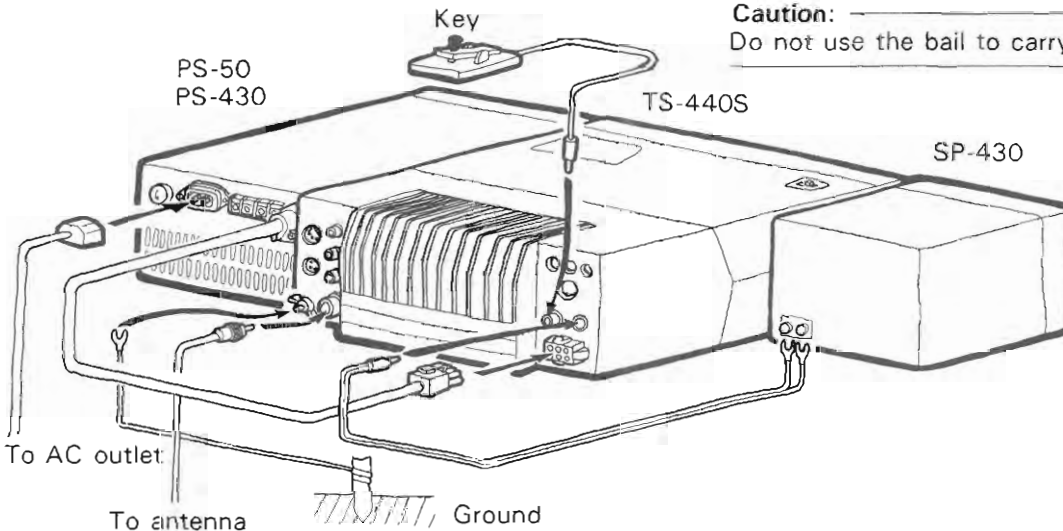

2-2-2. Grounding

Caution:

Never use a gas pipe or electrical conduit pipe.

Notes:

1. A ground connection that is a 1/4 wavelength or its multiple may provide a good DC ground, but it will not provide a good RF ground.
2. A city water pipe cannot be used as a good earth in some cases.

Making a good earth connection is important for preventing dangers such as electric shock and for emitting a high quality signal with minimum spurious radiation. Bury a commercially available ground rod or copper plate under the ground and connect it to the GND terminal of the TS-440S. A thick wire, cut as short as possible, should be used for the connection. To make a good earth connection, connect the GND terminal to a grounded metal water pipe.

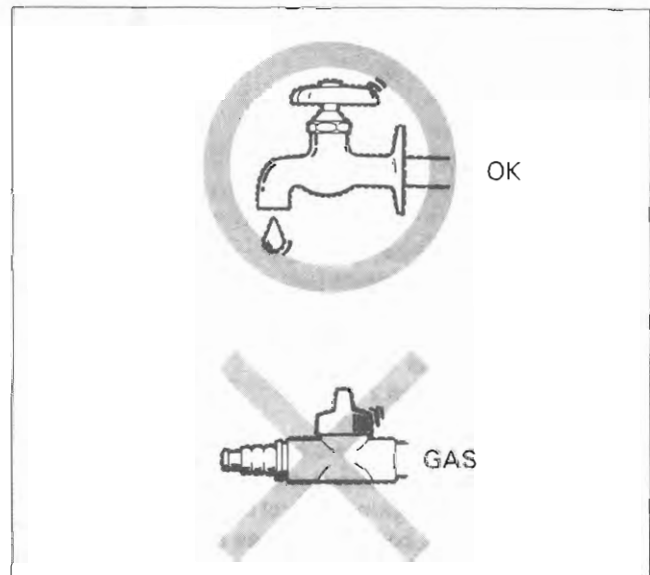

2-2-3. Antenna

Caution:

Protect your equipment—Use a LIGHTNING ARRESTOR.

Any of the common antenna systems designed for use on the high frequency amateur bands may be used with the TS-440S provided the input impedance of the transmission line is not outside the capability of the Automatic Antenna Tuner. The transmission line should be coaxial cable. An antenna system which shows a SWR (Standing Wave Ratio) of less than 1.5 : 1 when using 50 ohm coaxial transmission line, or a system that results in a transmission line input impedance that is essentially resistive, and between 20 and 150 ohms will take power from the transceiver through the AT unit.

2-2-4. Key connection:

Your key should be connected as illustrated in the figure below. When using an electronic keyer, make sure that polarity is set for positive. Always use shielded line from the key to transceiver.

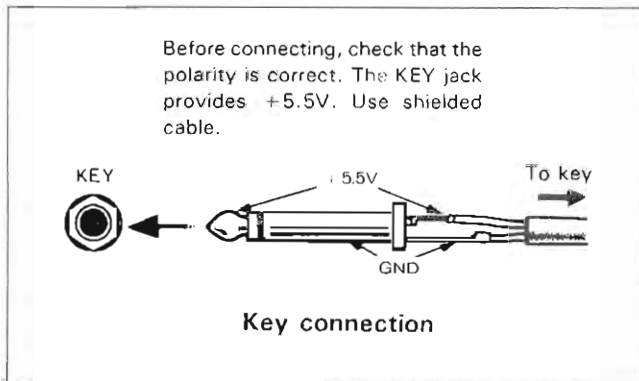

2-3. MOBILE

Being compact in design, this transceiver is ideal for mobile operation. Satisfactory mobile operation is achieved through proper power and antenna connection, and thoughtful transceiver installation and adjustment.

2-3-1. Mounting bracket installation

Secure the TS-440S under the dashboard using an optional MB-430 mounting bracket. As an alternative, use strapping, making sure that the TS-440S will not slip out of place while operating the vehicle.

Notes:

1. Do not install the TS-440S near the heater outlet.
2. Allow sufficient space behind the TS-440S to ensure proper ventilation.

2-3-2. Power supply connection

Cautions:

1. Turn POWER switch OFF before connecting/disconnecting the power cable.
2. Observe battery polarity.

DC power cable	
Red and white	+
Black and gray	-

3. When charging your vehicle battery, or when jump-starting a dead battery, ALWAYS disconnect the power cable from the back of the transceiver, or damage may result to the transceiver.

Connect the TS-440S power cable to the battery terminals, with consideration to current requirements and noise prevention. The maximum current drawn by the TS-440S reaches between 18 and 20A when transmitting. Therefore, the cable should be made as short as possible, using the specified fuse. Also, confirm that the power system of the car (including the battery and generator or alternator) will handle the increased load of the TS-440S.

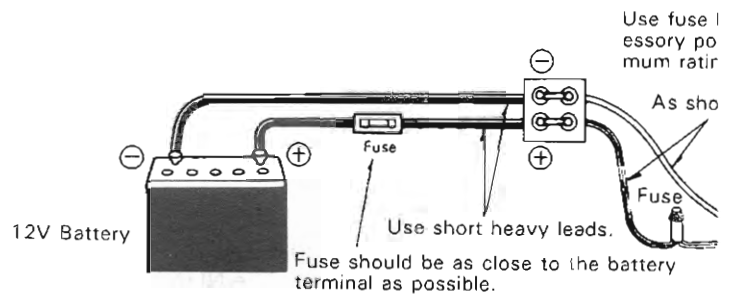

block battery acc-
sition. 20A mini-
g.

rt as possible. TS-440S

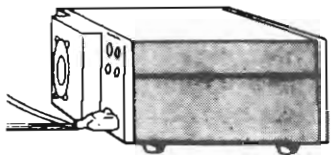

3. OPERATION

3-1. OPERATING CONTROLS

3-1-1. Front panel

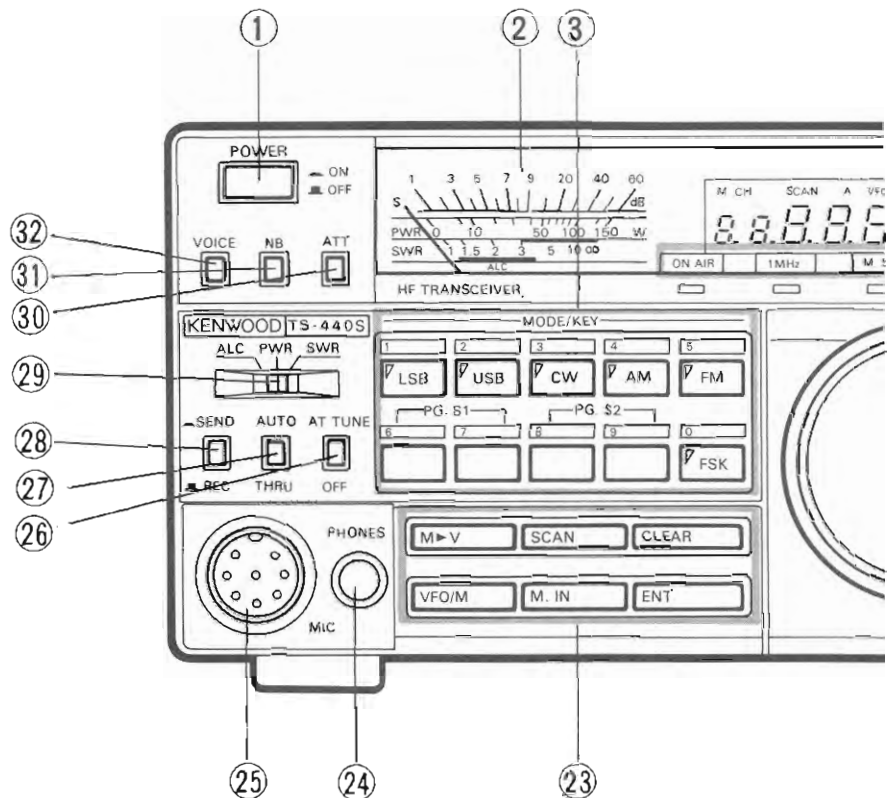

① POWER switch

Press to turn the power ON or OFF.

② Meter

During receive the meter is used as an S-meter. During transmit the function of the meter is controlled by the Meter switch ⑳, and provides either ALC level, PWR (power) or SWR readings.

③ MODE/KEY (Numeric Keypad)

These keys are used to select the desired mode of operation (USB, LSB, CW, AM, FM, AFSK). When programming a memory channel or directly entering a frequency these keys are used as a numeric keypad to enter the channel number or frequency.

④ Indicators

AT TUNE: Lights when the AT TUNE switch is ON. Turns itself OFF when the antenna tuner has completed tuning.

NOTCH: Lights when the NOTCH switch is ON.

F.LOCK: Lights when the F.LOCK switch is ON.

1 MHz: Lights when the 1 MHz step switch is ON.

M.SCR: Lights when the M.IN switch is pressed. When the memory scroll function is active you can review the contents of the memory channels without a break in the reception of the station you are listening to.

ON AIR: Lights during transmit.

⑤ Frequency display

The operating frequency is displayed down to the nearest 100 Hz. Also displays the memory channel number, RIT/XIT frequency, and includes indicators for memory, VFO A/B, scan, split and RIT/XIT operations.

⑥ FUNCTION switches

The switches included in this group are the RIT/XIT, T-F SET switch, and the VFO select switches. (See page 15.)

⑦ MIC gain control

Microphone gain can be adjusted during USB, LSB, AFSK and AM operations. Gain is increased thru clockwise rotation of this control.

⑧ CAR (Carrier level) control

This control sets the carrier level during CW, FM and AM operations. When transmitting in the CW mode, adjust so that the ALC meter pointer is within the ALC zone.

⑨ SQL (Squelch) control

This function operates in all modes, FM, USB, LSB, CW, AFSK, and AM.

This control is used to eliminate atmospheric noise, and receiver static noise during no signal periods. Slowly rotate the control clockwise to the point where the ambient noise just disappears, and speaker shuts off. This point is known as the squelch threshold point. Now you will only hear output from the speaker when an incoming signal is present. For weak signal reception this control should be fully counterclockwise.

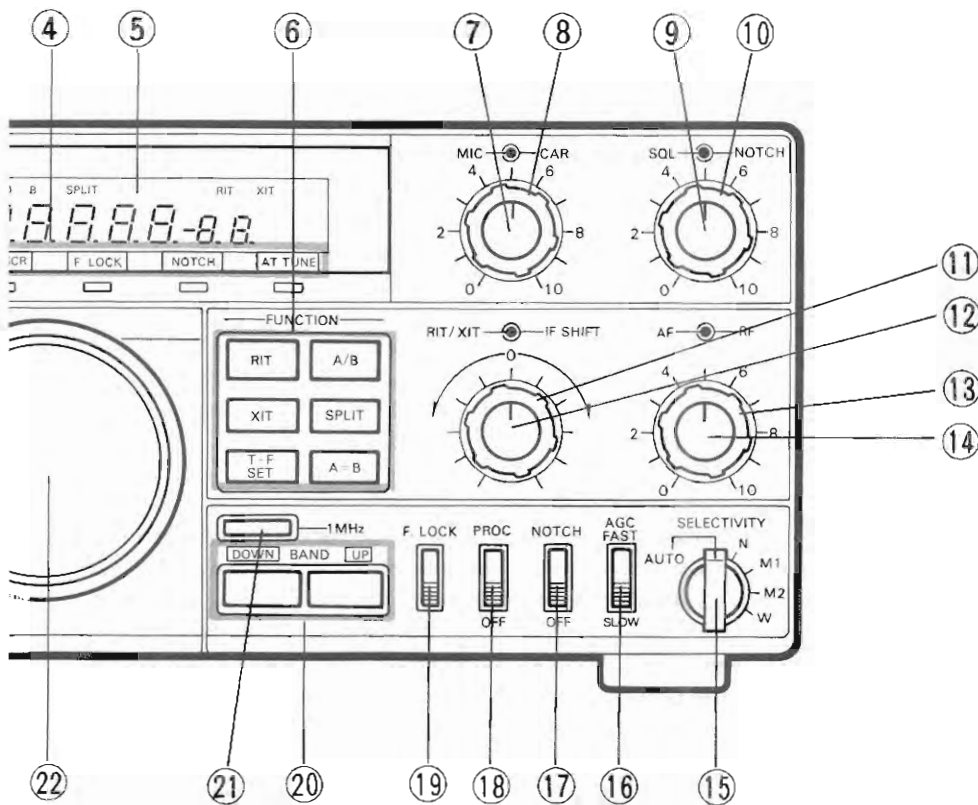

Note:

The squelch threshold position will vary from mode to mode, so you may have to readjust when you change modes.

10 NOTCH control

The NOTCH function is used to reduce or eliminate heterodyne, or CW type signals. The NOTCH filter will not be effective against SSB, AM or FM type signals. To use the control, place the NOTCH switch ON and slowly rotate the NOTCH control to reduce the interference. Normally the notch point will occur between the 11:00 and 1:00 o'clock position.

Notes:

1. The NOTCH frequency can be varied within a range of approximately 400 to 2600 Hz.
2. When an interfering signal such as a CW station appears, slowly rotate the NOTCH control. If you rotate the knob too quickly you may pass right over the notch point. Slow rotation will yield the best results.

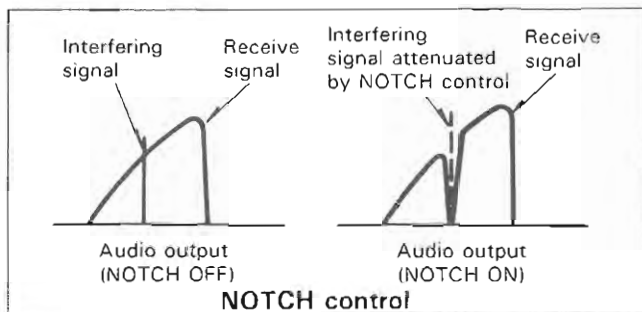

11 IF SHIFT control

Note:

The IF SHIFT control does not function in the AM or FM modes.

The IF SHIFT control allows you to shift the IF pass-band of the receiver without changing the actual center frequency of the receiver. This control is useful when there is interference near your center frequency. As the accompanying illustration shows rotating this control may place the interfering signal outside the receiver passband, allowing for easier copy. The operation of this control in the USB, LSB, AFSK, and CW modes is detailed below.

• **USB mode**

Interference from lower frequencies can be reduced or eliminated by rotating the IF SHIFT control in the ⊕ direction. This will cause the resulting audio frequencies to have a slightly treble response, i.e. low cut filter (low frequencies attenuated). Interference from higher frequencies can be reduced or eliminated by rotating the IF SHIFT control in the ⊖ direction. This will cause the resulting audio frequencies to sound a little bassy, i.e. high cut filter (high frequencies attenuated).

• **LSB/AFSK mode**

Interference from lower frequencies can be reduced or eliminated by rotating the IF SHIFT control in the ⊕ direction. This will cause the resulting audio frequencies to sound a little bassy, just the opposite of the effect in the USB mode. Interference from higher frequencies can be reduced or eliminated by

rotating the IF SHIFT control in the \ominus direction. This will cause the resulting audio frequencies to appear a little on the high side, again just the opposite of the USB mode.

• **CW mode**

The operation of the IF SHIFT control is similar to that for USB with the exception that you can control the tone of the CW note by using the RIT control.

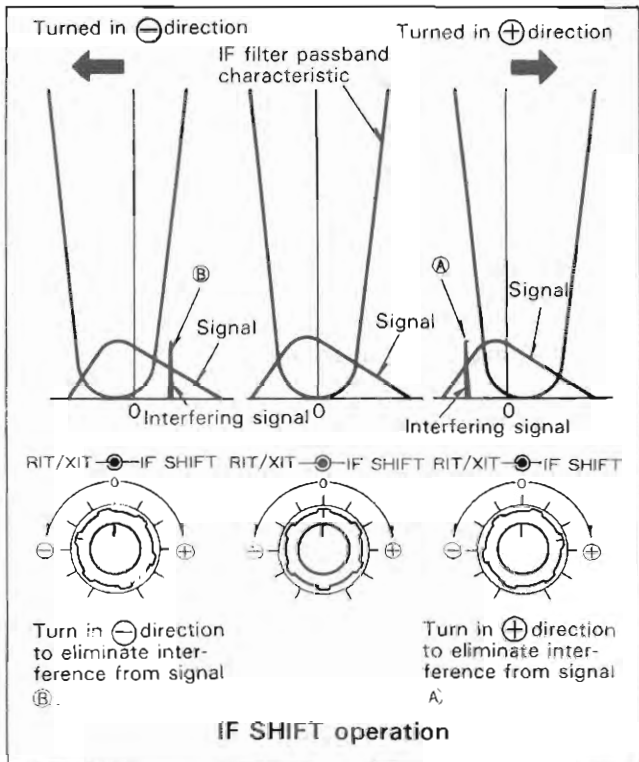

⑫ **RIT/XIT control**

• **RIT control**

When the transmit frequency of the distant station drifts a little bit during the QSO, but you do not wish to alter your transmit frequency to compensate, you may wish to make use of the RIT control function. This control allows shifting the receive frequency without shifting the transmit frequency. The RIT control allows you to shift the receiver frequency ± 1.2 kHz. This control is also useful for pileups when the DX station is transmitting a little above or below his receive frequency.

Notes:

1. The RIT offset is displayed on the main display. You can therefore preset the offset before you actually need to use it. When you move to another station make sure you turn OFF the RIT switch.
2. The figure at the right illustrates that the RIT display and the VFO display may not agree exactly in all instances since the RIT and VFO tune in 10 Hz steps. The normal resolution of the VFO is 100 Hz, so if the RIT or VFO is turned slowly the associated display may not update immediately. You will have to tune 100 Hz to see the display actually change.

VFO	RIT
14.000.0 0	0.0 0
13.999.9 9	-0.0 1
13.999.9 1	-0.0 9
13.999.9 0	-0.1 0
13.999.8 9	-0.1 1

• **XIT control**

When the RIT/XIT control is rotated with the XIT switch depressed the transmit frequency can be varied ± 1.2 kHz without affecting the receiver frequency.

Pressing the switch again releases the XIT function.

⑬ **RF gain control**

This control adjusts the gain of the receiver high-frequency amplifier section.

For normal receiver performance, and maximum gain, this control should be in the full clockwise position. If you are having trouble copying the desired signal make a note of the stations peak S-meter reading. Then, adjust the RF control counterclockwise, so that the meter needle is stationary at this level. Now, all signals that were less than the desired signal will be attenuated, such as static noise, etc., making the completion of the QSO easier.

If the incoming signal pegs the S-meter you can also reduce the receiver gain by counterclockwise rotation of the RF control. The S-meter pointer will always advance up-scale as the RF control is rotated counterclockwise, as a visual reminder that the gain of the radio has been reduced.

⑭ **AF gain control**

Turn the inside knob to increase or decrease the volume.

⑮ **SELECTIVITY switch**

When an optional filter is installed, the radio's passband can be switched to one of four different bandwidths.

The switch has five positions; AUTO, N, M1, M2 and W, that are used to select the bandwidth. The M1, and N positions are not active until the optional filters are installed, see the accompanying chart. This switch should normally be set to the AUTO position. The IF bandwidth will then be selected for optimum receiver characteristics, according to the MODE that has been selected. Manual override is possible by simple rotation of the SELECTIVITY control.

The table in section 6-1, CRYSTAL FILTER INSTALLATION on page 27 shows the bandwidth of each switch setting. Note the differences when the optional filters are installed. The YK-88C is used in the "N" position and the YK-88SN in the "M1" position.

Notes:

1. During transmit the wide filter position is selected regardless of the position of the SELECTIVITY switch.
2. When in the FM mode the bandwidth is always 15 kHz, regardless of the position of the SELECTIVITY switch.
3. When the SELECTIVITY switch is set to N or M1, and no optional filters have been installed, there will be no sound from the speaker. Refer to the optional filter installation procedure in the rear of this manual for information on installation of these options.

16 AGC switch

This switch selects the operating time constant of the AGC (Automatic Gain Control) circuit during receive. When the AGC switch is set to SLOW, the receiver gain and S-meter readings will react slowly to large input changes, and when set to FAST, the receiver gain and S-meter will react quickly to changes in the input signal level.

The normal position when using all modes is the SLOW position. When working weak signals, or high speed CW you might wish to use the FAST position.

Note:

This switch is disabled during FM operations.

17 NOTCH switch

When this switch is ON, the notch filter is activated.

18 PROC (Processor) switch

Effective transmit power output will increase when the PROC switch is turned ON during USB, LSB, AFSK, or FM mode operations.

Note:

When the speech processor function is used in the USB, LSB, or AFSK mode it is possible to overdrive the transmitter. An easy way to check for excessive modulation is to monitor the ALC meter. If the needle is over the ALC zone you are overmodulating. Reduce the MIC gain control setting until the needle remains in the ALC zone on voice peaks.

19 F.LOCK switch

The selected dial frequency is locked and cannot be changed except thru the use of the RIT/XIT controls, when this switch is ON.

20 UP/DOWN switches

Pressing the UP switch increases the frequency, and pressing the DOWN switch decreases it.

21 1 MHz step switch

This switch is used to determine if the UP/DOWN switches will function in 1 MHz steps or only thru the amateur bands. When the 1 MHz step position is selected, the 1 MHz indicator will light.

22 TUNING dial (VFO)

Rotate the knob to select the desired frequency. Fast tuning is possible by rotating the knob rapidly. This control may also be used to select the desired memory channel. The dial drag is adjustable by holding the outside knob and turning the inside knob clockwise to increase drag, and counterclockwise to decrease drag.

23 Program keys

- M►V:** Used to recall a frequency from memory to the VFO.
- SCAN:** Pressing during VFO operation will initiate program scan, and pressing during memory operation will initiate memory scan. Pressing during scan operation will cause the scan speed to toggle between 2 speeds, fast and slow.
- CLEAR:** Used to cancel memory storage operations, or to cancel an entry during direct keyboard entry of frequency using the ENT key.
- VFO/M:** Used to switch between memory or VFO operations.
- M.IN:** Used to enter data into a memory channel.
- ENT:** Used to directly enter a frequency from the numeric keypad.

24 PHONES jack

Output terminal for headphones.

25 MIC jack

Connector for a microphone.

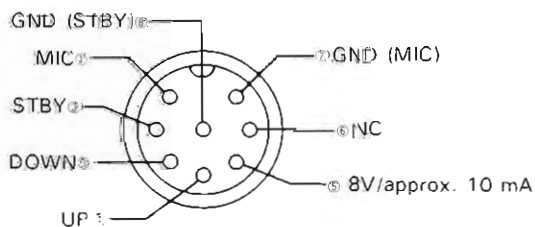

MIC connector (Front view)

26 AT TUNE switch

When this switch is turned ON with the AUTO/THRU switch is placed in the AUTO position, the automatic tuner will be engaged and the tuner will try to match the antenna.

27 AUTO/THRU switch

- AUTO:** The auto antenna tuner is used in transmit.
- THRU:** The auto antenna tuner is not used in transmit.

②8 Standby switch

This switch is used when you want to manually control transmit or receive.

SEND: Places the radio into transmit.

REC: Places the radio into receive.

The Standby switch is also used to clear an entry during direct entry of VFO frequencies, or when entering a memory channel.

②9 ALC/PWR/SWR meter switch

ALC meter

Used to monitor the drive level in USB, LSB, and AFSK modes.

PWR meter

Used to indicate the output power. Note that this meter is a peak reading meter, not an average reading meter.

SWR meter

Used to indicate the Standing Wave Ratio of the antenna and feedline connected to the ANT connector when the AUTO/THRU switch is in the THRU position.

③0 ATT (Attenuator) switch

The incoming receive signal level is attenuated by approximately 20 dB when this switch is activated.

When the incoming receive signal is very strong (20 dB over S-9), the signal should be attenuated to prevent distortion of the signal, thereby stabilizing the receiver performance. This is easily done by activating the ATT switch. This control is also useful when a strong signal is near your desired signal, while some loss will occur to the desired signal as well as the undesired signal, the use of the attenuator will sometimes allow you to complete the QSO.

③1 NB (Noise Blanker) switch

When pulsating noise, such as that caused by automobile ignitions is encountered, place the NB switch ON. This will provide approximately 40 dB's of attenuation to this interfering signal. If there is no noise present, the switch should be in the OFF position. This switch will not help to eliminate atmospheric or line noises, only pulse type noise.

③2 VOICE switch

When the optional VS-1 voice synthesizer unit is installed the operating frequency will be announced whenever the VOICE switch is depressed. For a dial frequency of 14.200.0 the frequency will be announced as: "one", "four", "point", "two", "zero", "zero", "zero", "zero".

Please refer to page 28 for installation instructions concerning the VS-1 Voice Synthesizer.

3-1-2. Rear panel

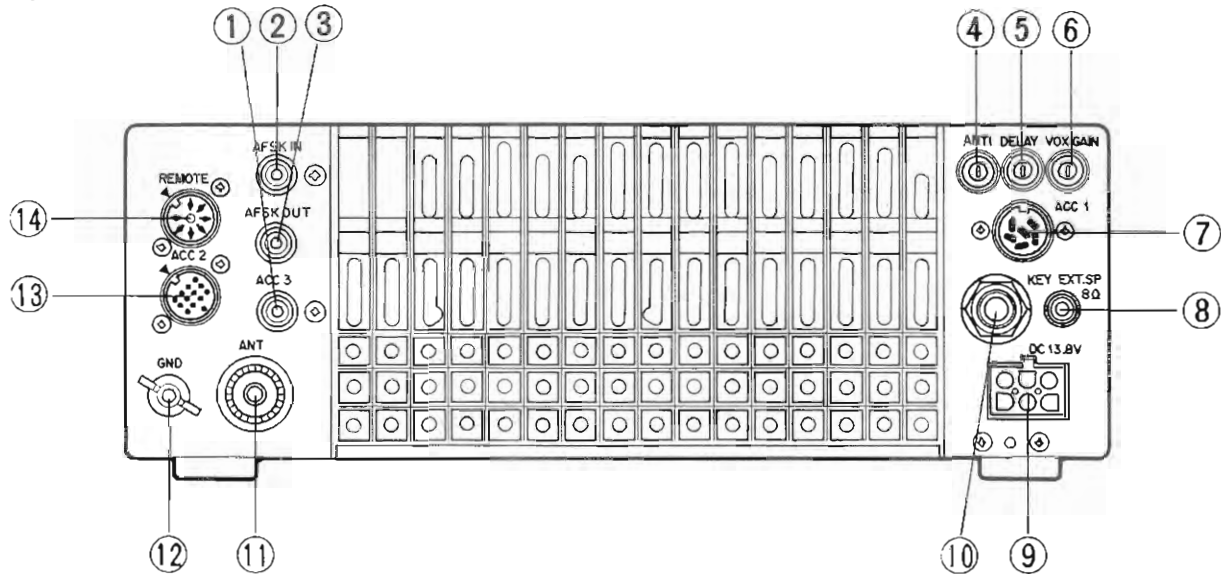

① ACC 3 terminal

Spare RCA type terminal. No internal connections have been made.

② AFSK IN terminal

AFSK input terminal.

③ AFSK OUT terminal

Constant level AF output terminal for AFSK operation.

④ ANTI VOX control

VOX operations are sometimes difficult with high speaker volume control settings. The ANTI VOX control is used to reduce the tendency of the VOX to activate from inputs from the speaker. The ANTI VOX control is not active when headphones are connected, for obvious reasons!



⑤ DELAY control

This control adjusts the "hang-time" that the radio will remain keyed after voice input has stopped.



⑥ VOX GAIN control

This control adjusts the sensitivity of the VOX amplifier. Adjust this control for your personal preference.



⑦ ACC 1 jack

This jack is designed for connection of the 6-pin DIN connector supplied with the optional interface unit.

⑧ EXT. SP (External speaker) jack

This jack is for connection of an external speaker.

⑨ DC power connector

This is used to connect the DC power supply.

⑩ KEY jack

Using shielded line, connect a 1/4" phone plug to this jack for CW operation. Open-terminal voltage is approximately 5.5 VDC.

⑪ ANT (Antenna) connector

This UHF connector should be attached to a suitable antenna for transmitting and receiving. The antenna cable should be 50-ohm coax, terminated with a PL-259 connector.

⑫ GND (Ground) terminal

To prevent electric shock, as well as RFI and BCI, connect the transceiver to a good earth ground.

13 ACC 2 jack

Terminal numbers and their applications are as follows:

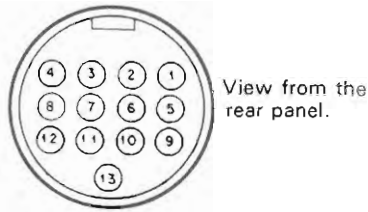

13-pin DIN plug

Pin No.	Pin Name	Application
1	NC	No connection
2	NC	No connection
3	Data output	Output level is fixed regardless of the AF control setting. Output voltage: 300 mV or more at maximum receiving input with 4.7 kΩ load.
4	GND	Grounding (The shielded wire of the audio output terminal is connected here.)
5	NC	No connection
6	NC	No connection
7	NC	No connection
8	GND	Grounding
9	MIC mute	Signal input from the MIC jack is muted. Grounding mutes signal.
10	NC	No connection
11	Data input	Input terminal for data communication. In SSB, MIC gain can be controlled by the MIC control. Input voltage: 500 mV or less (SSB: Voltage starts deflecting ALC. FM: Voltage providing ± 3.0 kHz modulation ratio.)
12	GND	Grounding (The shielded wire of the audio input is connected here.)
13	Standby	Standby terminal Grounding transmits.

14 REMOTE connector

Note:

When the control relay is used refer to section 5-8-10.

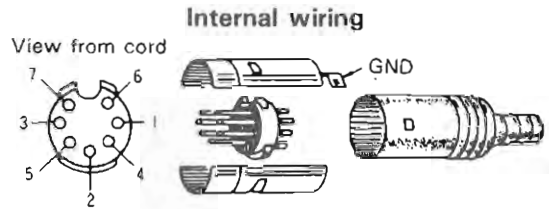
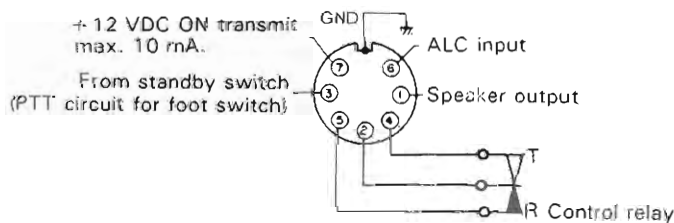

3-1-3. Top cover

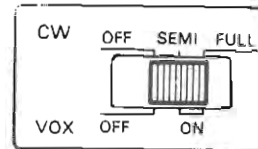

VOX/BREAK IN switch

VOX (Voice Operated Switch) operation is possible in LSB, USB, FM or AFSK mode operations. To activate the VOX circuitry place the VOX switch ON.

This control is also used to select either Full or Semi automatic break-in.

3-2. RECEIVE

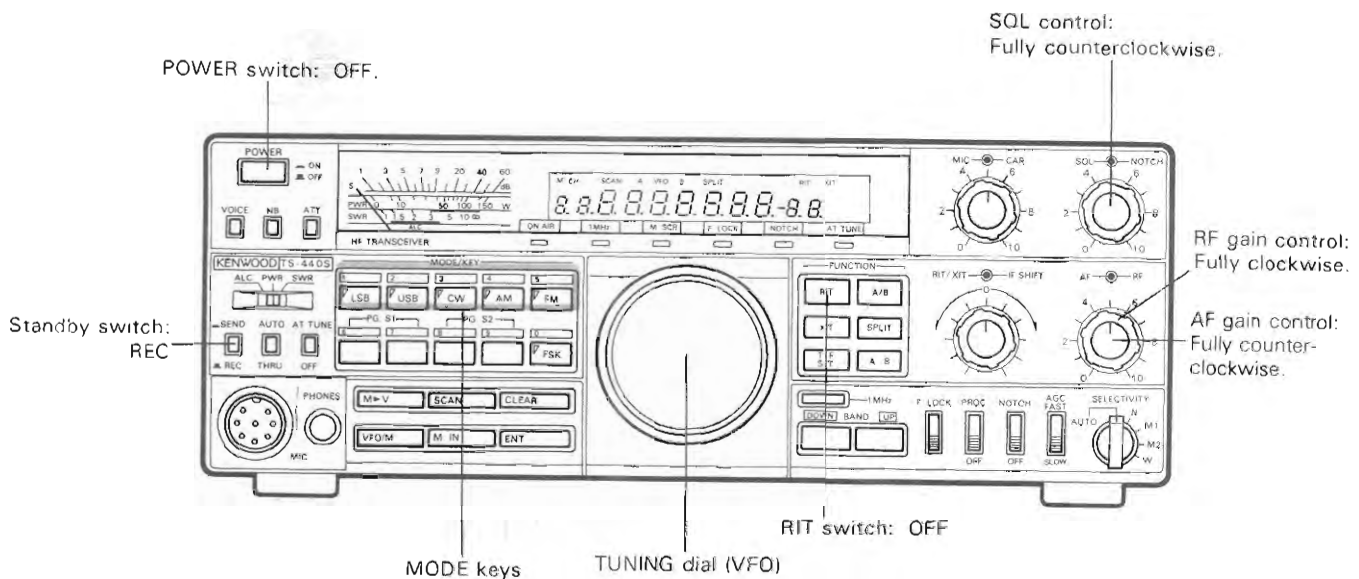

3-2-1. Initial setting

1. Preset the controls as shown in the accompanying illustration above.
2. Place the POWER switch to ON. (During fixed-station operation you must first turn ON your DC power supply, the PS-50 is recommended.)
3. The meter will illuminate and a frequency will appear in the display.
4. Set the BAND switches for the desired band. If you desire to tune a frequency other than one of the amateur radio frequencies, place the 1 MHz switch ON. With the 1 MHz switch ON the UP/DOWN switches will advance the frequency in 1 MHz steps, rather than thru the amateur radio bands.
5. Select the desired MODE using one of the mode switches.

Notes:

1. By international convention amateur radio frequencies below 10 MHz utilize the LSB (Lower Sideband) mode, and frequencies of 10 MHz and above use USB (Upper Sideband).
2. The TS-440S automatically selects the normal mode for you. The exact changeover point is 9.5 MHz. You can override this selection by pressing the desired mode switch.
6. Adjust the AF gain control for the desired volume.
7. Slowly rotate the TUNING dial until the desired signal can be heard clearly.
8. The desired receive frequency can also be entered directly by using the numeric keypad. For details of this operation please refer to the "Direct keyboard frequency entry" section on page 13.

3-2-2. CW zero-beat operation

Zero-beat operation with a station during CW mode operation

1. Set the RIT/XIT switches to OFF.
2. When an optional filter is not used, tune the TUNING dial so that the receive beat frequency is approximately 800 Hz. You can check this by turning the VOX OFF, and then closing your CW key. Then by using the sidetone oscillator, and the incoming receive signal you can zero-beat by turning the TUNING dial until the two tones are the same frequency.
3. When the YK-88C filter is used the simplest method to use is to adjust the TUNING dial for a maximum S-meter deflection.

Reception at the desired pitch after zero-beat operation.

1. After zero-beating turn the RIT switch ON, and adjust the RIT control for the desired pitch.
2. Adjust the IF SHIFT control for the strongest signal level.

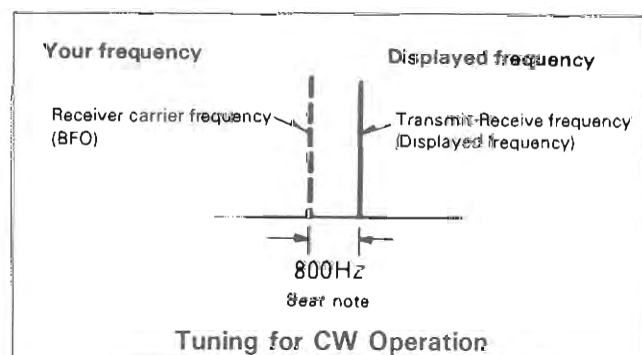

3-2-3. Direct keyboard frequency entry

Direct keyboard entry of the frequency is possible using the numeric keypad on the TS-440S. This allows rapid changes in frequency without the delays encountered when using other tuning methods.

1. Select the VFO mode.
2. Press the ENT key. The display will indicate " . . . ".

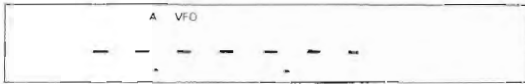

3. Enter the desired operating frequency from Most Significant Digit to the Least Significant Digit. You do not have to enter trailing zeros, but you must enter a leading zero for frequencies between 1 and 3.99999 MHz or two leading zeros for frequencies between 0.1 and 0.99999 MHz. (03.500.00 MHz).

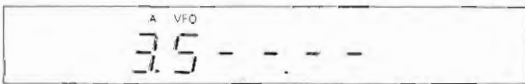

4. After the last digit has been entered press the ENT key again to signify you want the radio to change frequency. If you entered the frequency down to the nearest 10 Hz a beep will sound and the radio will automatically change to the new frequency without the need of pressing the ENT key for the second time.

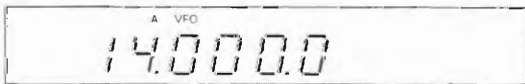

For example: To enter 14.200.00 MHz there are two methods:

Method one: Press [ENT], [1], [4], [2], [ENT].

Method two: [ENT], [1], [4], [2], [0], [0], [0], [0].



Note: Attempting to enter a frequency outside the tuning range of the radio will cause the display to return to " . . . ".

5. If you make a mistake while entering the frequency and have not yet pressed the ENT key, or entered the final digit, you may cancel the input by pressing either the CLEAR key or standby switch.

3-2-4. AM reception

There are cases during AM broadcast reception, where interference is noticeable when SELECTIVITY is W, but the intelligibility is poor with the radio in the M2 position, due to a lack of high frequency response. If this condition occurs place the SELECTIVITY switch to M2 and rotate the TUNING dial ± 1 kHz from the center frequency. It should be possible to find a point where the interference will be a little greater, intelligibility should be improved.

Another method utilizes the excellent receiver stability of the TS-440S by selecting USB or LSB and tuning to one of the sidebands of the AM signal. The only disadvantage to this method is that a 5 Hz beat tone might be detected along with the desired receive signal.

3-3. TRANSMIT

3-3-1. SSB (USB, LSB) mode

1. Set the MODE keys to USB or LSB. By international convention frequencies below 10 MHz utilize the LSB (Lower Sideband) mode, and frequencies above 10 MHz use USB (Upper Sideband). The actual switchover point on the TS-440S is 9.5 MHz. The TS-440S will select the proper mode when you tune to the desired frequency. You can override this by simply pressing the desired mode key.

2. Set the Meter switch to ALC.



3. Press the microphone PTT switch, or set the Stand-by switch from REC to SEND.
4. Speak into the microphone and adjust the MIC gain control so that the meter deflection does not exceed the ALC zone on voice peaks.

Note: Adjustment using the ALC meter provides greater accuracy than if you try and use the power meter for adjustment. Never adjust for ALC deflection above the ALC zone, as this will cause distortion of the transmitted audio signal.

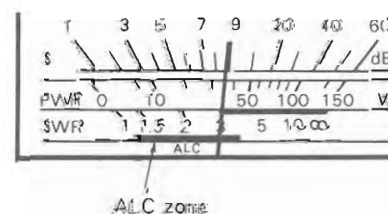

Note: Do not exceed the ALC zone on voice peaks.

3-3-2. CW mode

Set MODE keys to CW and set the Meter switch to ALC.

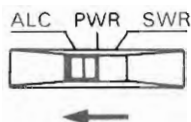

Placing the Standby switch to send and depressing the CW key will cause the radio to transmit.

Transmission is also possible when in the SEMI or FULL break-in mode by simply depressing the key, with the Standby switch in the REC position.

Adjust the CAR control until the meter deflection is within the ALC zone.

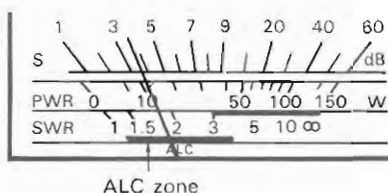

• SEMI and FULL break-in

Two break-in methods are provided with the TS-440S transceiver, SEMI and FULL break-in. With either break-in operation depressing the CW key will cause the radio to transmit without the need for manually switching the SEND/REC switch. The difference between FULL and SEMI break-in is that during FULL break-in operation it is possible to listen between dots and dashes, and that during SEMI break-in it is not.

Note:

With either SEMI or FULL break-in operation, cross band/cross mode operation is not possible. Additionally, when you are using FULL break-in operation you should not work cross band splits, only in the same band.

The TS-440S also provides a side-tone oscillator circuit to allow monitoring of your CW signal during transmission.

(a) Semi-automatic break-in

Depressing the CW key will automatically place the transceiver into the transmit mode. Transmit mode will be maintained for a period determined by the setting of the VOX DELAY control on the rear panel of the transceiver, even after the CW key is released.

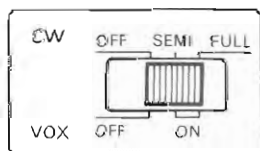

(b) Full-automatic break-in

Depressing the CW key will automatically place the transceiver into the transmit mode. Releasing the CW key will return the radio to receive immediately enabling reception between characters.

Caution:

The TL-922A/922 linear amplifier is not designed for full break-in type operation. Attempting to use this accessory in the FULL break-in mode cause damage to occur to the linear amplifier.

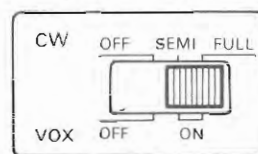

On occasion an electronic keyer may be used that has no method of producing a continuous transmit condition. In order to obtain a continuous carrier for tuning simply place the Standby switch to the SEND position.

3-3-3. FM mode

Select the desired frequency within the 28 MHz amateur radio band. Place the MODE key to FM and the Meter switch to ALC.

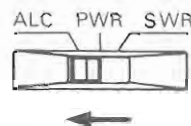

Press the microphone PTT switch or place the Standby switch to SEND.

Adjust the CAR control until the meter deflection is within the ALC zone. This will provide full power in the FM mode.

To decrease the power, place the Meter switch to PWR and while observing the meter rotate the CAR control counterclockwise until the desired output level is obtained.

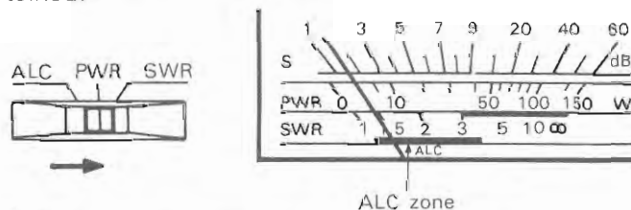

Notes:

1. The FM power output may fluctuate if running less than full output.
2. Ensure that an antenna with a low SWR is used. The TS-440S provides several protection circuits, continually loading into an antenna with a high SWR (3 to 1 or greater) will eventually cause damage to the final amplifiers.
3. The PWR meter reading may not be accurate with high SWR values. Use a good antenna for the most accurate readings.

• Subaudible tone

An optional subaudible tone unit TU-8 is available for installation in the TS-440S for accessing 10 meter FM repeaters. This tone is activated whenever the TS-440S is in the SPLIT mode.

3-3-4. AM mode

1. Set the Meter switch to PWR.
2. Set the MODE key to AM.
3. Place the Standby switch to SEND.
4. Adjust the CAR control so that the meter indicates 25 watts.
5. Place the Meter switch to ALC.
6. Adjust the MIC gain control so that the meter deflection does not exceed ALC zone on voice peaks.

3-4. AUTOMATIC ANTENNA TUNER (The AT unit AT-440 is required for this function.)

The automatic antenna tuner operates within the amateur radio bands from 3.5 thru 29.7 MHz.

1. Ensure that an antenna designed for use within the band you intend to operate on is properly connected to the antenna terminal.
2. Set the AUTO/THRU switch to the AUTO position.
3. Place the AT TUNE switch to the ON position. The AT TUNE indicator will light and the tuner will begin tuning. Then the CW mode indicator will light.
4. After a short period the AT TUNE indicator will go OFF and the motors will stop turning.
5. Place the AT TUNE switch to OFF.
6. Tuning is now completed. You may now carry out normal communications.

Notes:

1. When the AT TUNE switch is ON and the AT indicator lights but then goes out immediately it is an indication that the antenna was not that far off resonance and that tuning has been completed.
2. Normal operation is not possible until the AT TUNE switch has been turned OFF.
3. If the motors do not stop turning after approximately 30 seconds, place the AT TUNE switch to OFF, and then back to ON again. The tuner will attempt to tune again, and should find a good match. If the tuner will not stop after several tries it indicates some problem exists with the antenna system. Readjust the antenna and feedline before attempting to tune again.

3-5. DUAL DIGITAL VFO's

Operational convenience can be enhanced thru the use of both VFO A and VFO B.

3-5-1. Why two VFO's

Occasionally DX stations will utilize an operational procedure known as split frequency operation. When the DX station is in this mode he will be transmitting on one frequency and receiving on another. This is done in order for the DX station to be able to recognize the calls of stations during pile-ups.

Older transceivers required the use of an external VFO to allow this split frequency operation. The TS-440S, thru the use of microprocessor controls, effectively provides two separate VFOs in the same package. Several different controls and switches have been provided to increase the operators convenience when faced with this type of operation. The use of these controls is discussed below.

3-5-2. Split frequency

(a) A = B switch

Depressing this switch causes the data contained in the inactive VFO (the VFO that is not currently being displayed) to change to the same data contained in the active VFO (the one currently displayed). Both the frequency and mode are changed.

For example: VFO A is set at 7 MHz in LSB, and VFO B is 21 MHz in USB. VFO A is the active VFO (show on the display). Depressing the A = B switch will cause VFO B to change to 7 MHz in LSB.

(b) A/B switch

Allows selection of the desired active VFO. Each time this switch is depressed the active VFO will alternate between VFO A and VFO B.

(c) SPLIT switch

Allows the use of one VFO for transmit, and the other for receive (Split Frequency operation). For example: VFO A is the active VFO, and VFO B is the inactive VFO. Depressing the SPLIT switch will cause the TS-440S to receive on VFO A and transmit on VFO B. The mode of reception and transmission will follow the mode contained in the appropriate VFO memory. It is possible to work cross band, cross mode if desired.

To avoid confusion during contest, or pile-up operations we recommend using VFO A for receive and VFO B for transmit.

(d) T-F SET switch

Depressing this switch will allow you to rapidly set or check the transmit frequency, during SPLIT operations, without the need of actually transmitting.

This switch is especially convenient when you are trying to locate the transmit frequency of the station currently in contact with the DX station, since

depressing this switch allows you to receive on the transmit frequency as long as the switch is held depressed. The TUNING dial is active when this switch is depressed, so it is easy to change your transmitter frequency at the same time, if necessary. Releasing the switch will return you to the original receive frequency.

3-6. MEMORY

The TS-440S incorporates a convenient 100 channel memory that can be used to store and recall commonly used frequencies. These channels can be subdivided into 10 user-defined groups to tailor the TS-440S for optimum operation in a particular application. You can, for instance, assign channels 10 through 19 to the 160 meter band, channels 20 through 29 to the 80 meter band, channels 30 through 39 to the 40 meter band (LSB), channels 40 through 49 to the 20 meter band (USB), channels 50 through 59 to the 15 meter band, channels 60 to 69 to the 10 meter band (FM), channels 70 through 79 to the 12 meter band, and channels 80 through 89 to various shortwave bands. Channels 90 through 99 could then be assigned as split frequency channels. After completing channel assignments, you can then use the convenient memory scan function to automatically recall the stored frequencies on a group basis.

3-6-1. Memory Entry

1. With the TS-440S in the VFO mode, select the desired operating frequency and mode as described in previous sections.

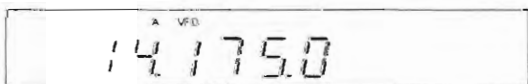

2. Press the M.IN switch. The radio will enter the Memory Scroll (M.SCR) mode. The current memory channel number (M.CH), frequency and mode will be displayed, but the actual operating frequency and mode will remain unchanged allowing uninterrupted reception.



3. Select the desired memory channel using one of the three methods described below.
 - a. Turn the TUNING dial until the desired channel number is displayed (One revolution of the dial cover about 10 channels).



- b. Enter a two digit channel number using the numeric keypad, being sure to include the leading zero for channels 00 through 09. Pressing the CLEAR key or the standby switch before pressing the second digit will return you to the original channel.

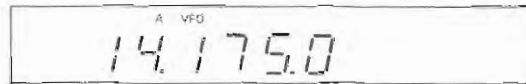

- c. Use the UP/DOWN switches and/or microphone UP/DOWN switches to scroll thru the different memory positions.
5. When the desired memory channel is displayed, press the M.IN key again. The current frequency and mode will be stored, the scroll mode will be cancelled, and the TS-440S will return to the operating mode and frequency that was displayed before the M.IN key was pressed initially. Note that if RIT was selected prior to step 2, the actual frequency stored will be the indicated frequency plus or minus the RIT variable.

3-6-2. Transferring memory information to the VFO.

1. Press the VFO/M key to select the memory mode.

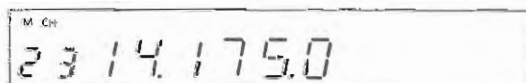

2. Select a channel using any of the methods discussed under the Memory Entry section.



3. Press the M>V key. The stored data will be transferred to the active VFO allowing you to begin tuning from that point. The TS-440S automatically returns to the VFO mode when the M>V key is depressed.

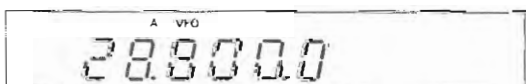

Notes:

1. The RIT/XIT status will be copied from the memory to the VFO when the M>V key is depressed.
2. When data is transferred from the split frequency memory, the active VFO is loaded with the receive data and the inactive VFO will be loaded with the transmit data. The TS-440S will then automatically enter the SPLIT mode.
3. This operation will not function if no data is con-

tained in the displayed memory channel.

4. Data in the VFO is replaced by the memory data. Memory data is not lost during this operation.

3-6-3. Transferring data between memory channels

1. With the TS-440S in the memory mode, press the M.IN key and scroll to the channel that you want the data to be transferred to.

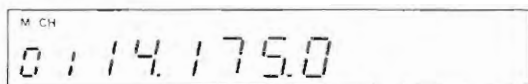

2. Press the M.IN key. The frequency and mode of the memory channel that appeared before you pressed the M.IN key will duplicated in the new channel.

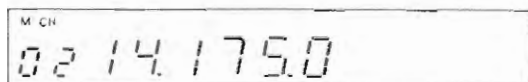

3-6-4. Entering/Transferring data in the split frequency channels

Separate transmit and receive frequencies may be entered into memory channels 90 through 99. The procedure is similar to that given for the other channels with the following exception:

1. The active VFO frequency and mode is stored in the receive memory, and the inactive VFO frequency and mode is stored in the transmit memory, regardless of whether the SPLIT function is ON or OFF.
2. The RIT offset is stored in the receive memory, and the XIT offset in the transmit memory.
3. When data is transferred from the general memory section into the split frequency memory section the transmit and receive frequencies will be the same.
4. Only the receive memory will be transferred into general memory during transfer operations from the split memory area.

3-6-5. Clearing a memory channel

Two methods may be used to clear a memory channel:

1. M.IN switch

Transferring information from a vacant channel, i.e. one that has no stored information, thru the use of the M.IN switch, as described previously in section 3-6-1 is one method of "clearing" a memory channel.

2. ENT switch

Data may also be erased by depressing the ENT key while depressing the CLEAR key.

3-6-6. Memory recall

Fixed channel type recall is possible when using the VFO/M key to recall memory channel information. The stored frequency cannot be changed, although the RIT/XIT function is active.

1. Press the VFO/M key. The memory channel number, mode, and stored frequency data will be displayed. If a channel contains no data, only the channel number will be displayed.

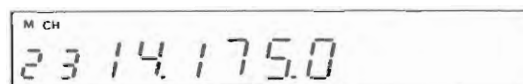

2. Select the desired memory channel using the methods described under Memory Entry section.

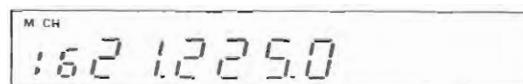

3. To return to the VFO mode, press the VFO/M key again.

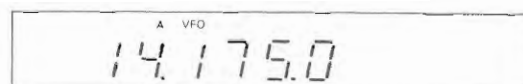

Notes:

1. RIT/XIT will be cancelled when the TS-440S is switched from the VFO mode to the memory mode, but will be restored when the TS-440S returns to the VFO mode.
2. When the TS-440S is switched from the memory mode to the VFO mode, the VFO will be set to the RIT/XIT variable specified when the data was programmed in to memory.

3-7. SCAN

3-7-1. Memory scan

Memory scan operates from memory channel 00 thru memory channel 99 at approximately 3-4 second intervals, or you may specify which memory groups you want to scan. Only these memory channels with data entered are scanned.

To initiate memory scan of all memory channels

1. Press the VFO/M key to select the memory mode.
2. Press the SCAN key. Scan will begin at memory channel 00, or the lowest numbered channel containing data.
3. You can stop scanning by pressing the CLEAR or microphone PTT switch. Pressing the PTT switch will allow you to continue scanning from the point that you stopped, and pressing the CLEAR key will allow you to start scanning from the beginning.
4. To resume scan press the SCAN key again.

To initiate memory scan of specific memory channel groups

1. Press the VFO/M key to select the memory mode.
2. Press and hold the SCAN key.
3. You may specify which memory groups you want to scan by depressing the key that corresponds to the ten position of the memory channel group.

0	Memory channels 00 thru 09
1	Memory channels 10 thru 19
2	Memory channels 20 thru 29
:		:
:		:
:		:
9	Memory channels 90 thru 99

In example 1 we want to scan only Group 2, so we would press the 2 key. In example 2 we want to scan Group 1 and Group 2, so we would press the 1 key and then the 2 key.

Example 1

Example 2

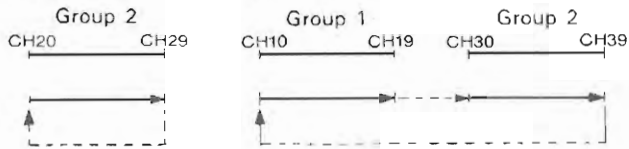

4. You can stop scanning, or resume scan using the same methods described above for the entire memory scan.

3-7-2. Program scan:

Two programmable scan ranges are provided on the TS-440S transceiver. PG.S-1 (Program Scan range 1) utilizes memory channels 06 and 07 to specify the upper and lower scan limits. PG.S-2 (Program Scan range 2) utilizes memory channels 08 and 09 to specify the upper and lower scan limits.

To initiate PG.S

1. Press the VFO/M key to select VFO operation.
2. Press and hold the SCAN key.
3. To initiate PG.S 1 press the 6 key, and then release both the 6 and the SCAN keys. Scan will begin on the frequency programmed in memory channel number 6 and proceed in 10 Hz steps to the upper limit stored in memory channel 7, then return to channel 6 and begin again.

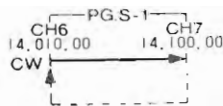

4. To initiate PG.S 2 press the 8 key, and then release both the 8 and the SCAN key. Scan will proceed in the limits specified in memory channels 8 and 9, just as for PG.S 1.

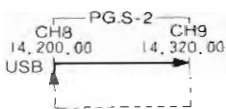

5. If you want to scan both ranges PG.S 1 and PG.S 2, press the 6 and then the 8 key while holding the SCAN key down, and then release the SCAN key. Scan will proceed thru the limits in memory channels 6 and 7, thru the limits in memory channels 8 and 9, and then return to begin the process again.

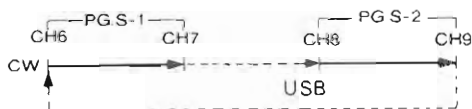

6. To stop scanning press the PTT switch, or the CLEAR key. Pressing the SCAN key allows scan to resume from the point you stopped.

Note:

The TS-440S microprocessor remembers the various scan parameters that you have specified and will follow whatever you have entered the next time you press the SCAN key.

Example 1: Memory mode

Previously programmed memory scan data was to scan channels 20-29 and 40-49.

To scan this same range again simply press the SCAN key.

Example 2: VFO mode

Previously entered program scan data was to scan both PG.S1 and PG.S2.

To initiate program scan over these two ranges again simply press the SCAN key.

The TS-440S will continue to execute scan according to the above parameters until you manually change the information. This saves a lot of key strokes if you always scan the same ranges, etc.

3-7-3. Scan speed

Two scan speeds are available with the TS-440S. To change the speed press the SCAN key after you have initiated scan. You will be able to toggle between fast and slow each time you press the key.

Note:

The scan step size depends upon the mode that has been selected for SSB, CW and AFSK the step size is 10 Hz, for FM and AM the step size is 100 Hz.

3-7-4. Memory channel lockout

This transceiver has a memory channel lockout function which allows you to temporarily skip unwanted memory channels during memory scan.

1. Press the VFO/M key to enter the memory mode.
2. Select the memory channel that you want to skip using the numeric keypad, the TUNING knob, or the UP/DOWN microphone or BAND switches.
3. Press the CLEAR switch.

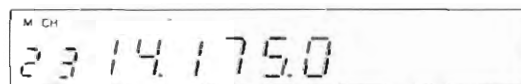

4. A decimal point will appear in the M.CH display to indicate that the channel will be skipped.

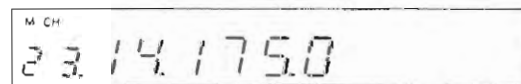

5. To cancel the lockout, select the desired channel and then press the CLEAR switch. The decimal point will go out indicating that the channel will again be scanned.

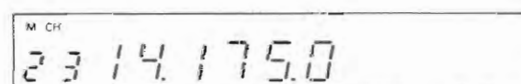

3-8. AFSK

3-8-1. Reception

Note:

An RTTY terminal is required to receive and display/print the RTTY signal.

1. The AFSK mode utilizes the LSB carrier frequency, which conforms to international conventions.
2. When the optional YK-88C filter is installed, the normal receiver bandwidth is 500 Hz when the SELECTIVITY switch is set to the AUTO position, and the MODE switch is in AFSK.

The accompanying diagram illustrates the relationship between the carrier and the passband width.

3. The demodulated AFSK signal is sent from the AFSK OUT terminal on the rear panel.
4. This completes the preparation for using the AFSK mode.

Note:

Before connecting the terminal you should review the contents of the instruction manual provided with that terminal unit.

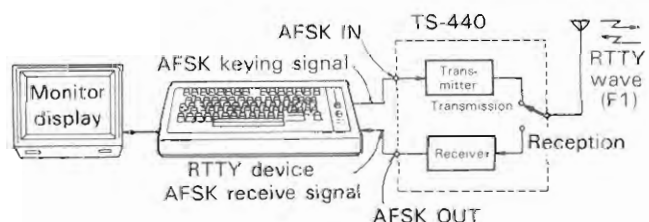

The figure below shows the frequencies relationship.

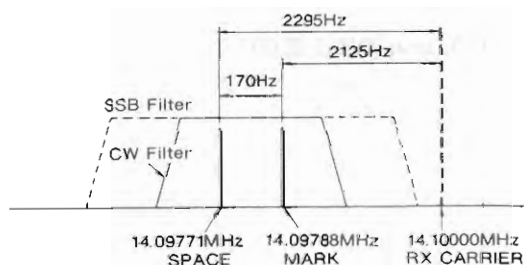

3-8-2. Transmit

Note:

Key down periods of 1 hour will require a cool down period of approximately 30 minutes. The PS-50 heavy-duty supply is recommended for continuous duty transmission.

1. Ensure that your terminal is set up for AFSK type keying.
2. Connect the terminal units AFSK output jack to TS-440S AFSK IN jack, and the terminal unit's AFSK input jack to the TS-440S AFSK OUT jack on the rear panel of the transceiver. The terminal units standby (PTT) terminal should be connected to the standby terminal on the REMOTE connector

of the TS-440S. (See page 11 for the REMOTE terminal pin configuration.)

3. Place the MODE key on the TS-440S to AFSK, and the Meter switch to ALC.
4. To transmit, either place the SEND/REC switch on the TS-440S to SEND, or use the PTT signal from your terminal unit.
5. When using AFSK, you can also apply your transmit signal tones to pin number 1 of the microphone connector, if you do not wish to use the two jacks on the rear of the TS-440S. To adjust the power output in AFSK, increase or decrease the MIC gain control setting. A mid-scale ALC reading will yield full power output.

Notes:

1. AFSK operation requires terminal unit designed to supply this type of operation. You cannot use FSK tones with an AFSK jack!
2. The AFSK oscillator circuit should provide audio tones of 2125 and 2295 Hz. Lower tones may cause spurious output due to the higher harmonic content present with these lower frequencies.
3. The TS-440S and RTTY terminal unit should use separate power supplies, in order to prevent RFI (Radio Frequency Interference).
4. During AFSK mode operation, the microphone switch should be OFF or ground pin No. 9 of the ACC 2 jack, or the microphone disconnected, if you are using the AFSK jacks on the rear panel.
5. The AFSK input level should be less than 100 mV.

3-8-3. AMTOR operation

For AMTOR operation, you should reverse the transmit/receive input polarity on your AMTOR terminal, since AFSK on the TS-440S operates in the LSB mode. If you cannot reverse the polarity, you should select the USB mode on the TS-440S.

During AMTOR operation, the microphone switch should be OFF, or ground pin No. 9 of the ACC 2 jack, or the microphone disconnected, if you are using AFSK IN/OUT jacks on the rear panel.

3-9. OPERATION WITH A LINEAR AMPLIFIER

The TS-440S may be operated with any conventional linear amplifier which will accept up to approximately 125 watts of RF drive, has a low current DC operated keying circuit, and returns approximately -8 to -1 VDC ALC back to the exciter. Please note that in order to operate full QSK (FULL break-in) the linear amplifier must also be QSK capable.

Refer to the REMOTE connector diagram on page 11 and section 5-8-10.

Initial linear amplifier tune-up should be performed with the TS-440S set for approximately 50 watts output to reduce wear and tear on both the linear, and the TS-440S. Use of a dummy load is strongly recommended, since the bands are already sufficiently crowded.

4. CIRCUIT DESCRIPTION

4-1. GENERAL DESCRIPTION

The TS-440S utilizes double conversion for FM transmissions, and triple-conversion for all other transmission modes, and for all modes in receive. The intermediate frequencies are 45.05 MHz, 8.83 MHz and 455 kHz.

A wide dynamic range is made possible thru the use of 2SK125 junction FET's in the receiver section's 1st and 2nd mixers, and by a 3SK73 dual-gate MOS FET in the 3rd mixer.

An integrated circuit balanced modulator (AN612) is used in the 1st transmitter mixer and 2SK122's are used in the 2nd and 3rd mixers. The PLL circuit, consisting of 5 loops, and the digital VFO are controlled by a single reference oscillator circuit. IF SHIFT and 10 Hz tuning steps are provided thru the use of this system.

4-2. TRANSMITTER SECTION

The incoming microphone audio is routed to the IF unit where it is amplified by the microphone amplifier and then distributed to the SSB, FM and VOX circuits. The SSB signal is applied to the balanced modulator, then amplified and converted to the 1st IF frequency of 455 kHz. This DSB (Double Side Band) signal is filtered to obtain the SSB signal. The SSB signal is mixed with the local oscillator frequency of 8.375 MHz in the 1st mixer to obtain the 2nd IF signal of 8.83 MHz. This signal is filtered by a CF (Ceramic Filter) to remove the unwanted by-products of the mixing action. The filtered output is applied to the RF unit.

In the RF unit the signal is mixed with the HET OSC frequency of 36.22 MHz by the 2nd mixer to obtain a frequency of 45.05 MHz. This signal is combined with the VCO signal in the 3rd mixer to obtain the transmit frequency which is applied to the Final unit via a LPF (Low Pass Filter). The Final unit amplifies the signal to the desired power level and then routes the signal thru an additional LPF to the antenna terminal, or the Antenna Tuner, if installed.

4-3. RECEIVER SECTION

The incoming signal for the antenna is fed to the receive band-pass filters in the RF unit, via a front panel controlled attenuator circuit. Selection of the desired BPF is accomplished thru data supplied from the Control unit. Signals from the BPF are mixed with the VCO signal in the 1st RX mixer to obtain the 1st IF frequency of 45.05 MHz. This signal is filtered by a MCF (Monolithic Crystal Filter) and applied to the 2nd RX mixer. This mixer combines the 1st IF frequency with the HET OSC frequency of 36.22 MHz to obtain the 2nd IF frequency of 8.83 MHz.

The 2nd IF frequency is split into two paths, one to the noise blanker circuits, and the other past the noise blanking gate to the 2nd IF filter. The signal that is taken from the output of the 2nd IF filter is applied to the 3rd RX mixer, via a buffer amplifier, where it is mixed with the local oscillator frequency of 8.375 MHz, to obtain the 3rd IF frequency of 455 kHz.

This 3rd IF frequency is either amplified and then demodulated by the FM detector IC, for FM operation, or applied to the 455 kHz filter. After filtering the signal is amplified and applied either to the SSB or AM detector circuits.

4-4. CIRCUIT BOARD DESCRIPTION

The TS-440S contains the following major units: RF unit, IF unit, Control unit, PLL unit, Filter unit, AT unit, etc. A brief description of these units follows.

4-4-1. RF unit (X44-1680-00)

The receive section of this unit includes the BPF's for each band, the 1st RX mixer, a 45.05 MHz MCF, the 2nd RX mixer, noise blanker circuits, and an 8.83 MHz MCF. The transmit section includes the 2nd TX mixer, 3rd TX mixer, amplifier circuits, FM microphone amplifier circuit, microphone limiter circuits, and four VCO's required to cover the frequencies from 100 kHz to 30 MHz.

4-4-2. IF unit (X60-1300-00)

The receive section of this unit contains the 8.83 MHz filter, 3rd RX mixer, 455 kHz filter, detector, and low frequency amplifiers. The transmit section contains the microphone amplifier, balanced modulator, 1st TX mixer, 8.83 MHz filter, etc. This unit also includes the timing circuit which controls the CW break-in circuit, and the 8.375 MHz local oscillator circuit.

4-4-3. Control unit (X53-1450-00)

The unit is centered around the main microprocessor, and provides a wide variety of control signals for all the various units.

4-4-4. PLL unit (X50-2050-00)

Five PLL loops are provided, as well as the reference crystal oscillator (36 MHz).

4-4-5. Final unit (X45-1470-00)

This unit amplifies the TX RF signal for transmission. TS-440S has an output of 100 W. This is accomplished by utilizing a three-stage final amplifier section having a relatively low collector loss figure, and a high efficiency cooling system.

4-4-6. Filter unit (X51-1340-00)

Provides for a high quality transmitter output by reducing unwanted harmonic emissions. This unit also detects the forward and reflected power sensing circuits for ALC, SWR and Antenna Tuner circuits.

4-4-7. Automatic Antenna Tuner unit (X57-1150-00)

This unit consists of the tuner and control sections. The tuner section consists of three coils and motor driven variable capacitors which form the actual tuning circuit. The control section takes the information provided by the filter unit, as well as band and frequency data provided by the RF unit to control the variable capacitors, and switching off the coil. The automatic antenna tuner operates from 3.5 thru 29.7 MHz.

5. MAINTENANCE AND ADJUSTMENT

5-1. GENERAL INFORMATION

Your transceiver has been factory aligned and tested to specification before shipment. Under normal circumstances the transceiver will operate in accordance with these operating instructions. All adjustable trimmers and coils in your transceiver were preset at the factory and should only be readjusted by a qualified technician with proper test equipment.

Attempting service or alignment without factory authorization can void the transceiver's warranty.

When operated properly, the transceiver can give years of service without requiring realignment. The information in this section gives some general service procedures which can be accomplished without sophisticated test equipment.

5-2. SERVICE

Should it ever become necessary to return the equipment to your dealer or service center for repair, pack in its original box and packing, and include a full description of the problems involved. Also include your telephone number. You need not return accessory items unless directly related to the service problem.

You may return your radio for service to the Authorized TRIO-KENWOOD Dealer from whom you purchased it. A copy of the service report will be returned with the unit. Please do not send sub-assemblies or printed circuit boards. Send the complete unit, in its original boxes and packing.

Tag all returned items with your name and call for identification. Please mention the model and serial number of your radio in any correspondence, whether phone or written. For future reference, record this in-

formation in the space provided on the back cover of this manual.

Service note:

Dear OM, if you desire to correspond on a technical or operational problem, please make your note short, complete, and to the point. And PLEASE make it readable.

Please list: Model and serial number.

The question or problem you are having. Please give sufficient detail to diagnose: other equipment in the station, meter readings and anything you feel might be useful in attempting diagnosis.

Caution:

Do not pack the equipment in crushed newspapers for shipment! Extensive damage may result, during shipping.

Notes:

1. Record the date of purchase, serial number and dealer from whom purchased.
2. For your own information, retain a written record of any maintenance performed on the unit.
3. When claiming warranty service, please include a photocopy of the bill of sale, or other proof of purchase showing the date of sale.

5-3. CLEANING

The knobs, front panel and cabinet of the transceiver are likely to become soiled after extended use. The knobs should be removed from the transceiver and cleaned with a neutral soap and warm water. Use a neutral soap (not harsh chemicals) and damp cloth to clean the cabinet and front panel.

5-4. IN CASE OF DIFFICULTY

The problems described in this table are failures caused in general by improper operation or connection of the

RECEPTION

transceiver, not by defective components. Examine and check according to the following table. If the problem persists, contact an authorized agent or service station.

Symptom	Probable cause	Corrective action
Indicators do not light and no receiver noise is heard when the POWER switch is turned on.	<ol style="list-style-type: none"> 1. Bad power cable or connections. 2. Blown power supply fuse. 3. Power supply is OFF. 	<ol style="list-style-type: none"> 1. Check cables and connections. 2. Check for the cause of the blown fuse and replace the fuse.
Nothing is displayed or wrong digits are displayed when the POWER switch is turned on.	The microprocessor malfunctions. This occurs when the battery is old or the supply voltage drops extremely on the occasion of consuming large current.	<ol style="list-style-type: none"> 1. Adjust the supply voltage to nominal voltage $\pm 10V$ with use of a boosting transformer. Use a 12 to 16V battery. 2. Turn the POWER switch on again.
No signal is received even when the antenna is connected.	<ol style="list-style-type: none"> 1. SQL control fully clockwise. 2. Microphone PTT switch is in the transmit position, and the TS440S is in the transmit mode. 3. SELECTIVITY switch is set to "N" or "M1" and no optional filter is installed. 	<ol style="list-style-type: none"> 1. Turn the SQL control counter-clockwise. 2. Set the PTT switch to the receive position. 3. Ensure the SELECTIVITY switch is set to either "AUTO", "M2", or "W"
An antenna is connected, but no signal is received and the S-meter fully deflects.	RF control is too low, decreasing the high frequency circuit gain.	Turn the RF gain control fully clockwise.

Symptom	Probable cause	Corrective action
The S-meter deflects and stays at a certain position even with no signal.	1. Low AC line voltage. 2. RF gain control closed.	1. Use a step-up transformer to raise the line voltage. Use a 12 to 16V battery. 2. Turn the RF gain control fully clockwise.
Signal is received, but no sound is heard.	MODE key position is incorrect.	Change the MODE key to the correct mode.
SSB received signal is extremely high cut or low cut.	IF SHIFT control is wrong adjusted.	Set the control to the center (click position).
Frequency is not changed by pressing the BAND switch or turning the tuning control.	F. LOCK switch is ON.	Set F. LOCK switch to OFF.
Program scan fails.	Memory channel is 6 and 7 or 8 and 9 are empty.	Store the frequency.
Memory scan fails.	Memory is empty.	
Display goes out with VFO/M ON.	When nothing is stored in the memory channel, a channel is displayed and blanked with only the decimal point displayed.	

TRANSMISSION

Symptom	Probable cause	Corrective action
No output in SSB (RF and ALC meters do not deflect.)	1. Open microphone cable or bad microphone. 2. Low microphone gain.	1. Check the microphone. 2. Increase the MIC gain control.
VOX does not operate.	1. VOX GAIN control too low. 2. ANTI VOX control requires adjustment.	See section 3-1-2, VOX GAIN control.
VOX trips by speaker output.	ANTI VOX control requires adjustment.	See section 3-1-2, ANTI VOX control.
No output in CW	The key plug is incompletely inserted or KEY contact failure.	1. Insert the key plug fully. 2. Turn the CAR control clockwise.
Linear amplifier does not key.	1. Internal connector was not moved. 2. REMOTE connector is miswired, or has a poor contact.	1. Move the connector as described in section 5-8-10. 2. Correct wiring.

5-5. MICROPROCESSOR BACK-UP LITHIUM BATTERY

A lithium battery is contained in the transceiver to retain memory. Turning off and POWER switch, disconnecting the power cable, or a power failure will not erase the memory. The battery should last for approximately five years. When the battery discharges, an erroneous display may appear in the display. Lithium battery replacement should be performed by an authorized KENWOOD service facility; either your KENWOOD dealer, or the factory, since this unit contains CMOS type circuitry.

Notes:

- When the lithium battery is replaced, the microprocessor must be reset, using the procedure in section 5-6.
- When the lithium battery fails, the radio's microcoded functions are NOT affected. Only information stored in memory will be cleared.

5-6. MICROPROCESSOR RESET

When the microprocessor has functioned erroneously or when setting the transceiver in the initial state, switch on the power with the A = B switch pressed.

Note:

The microprocessor can be easily reset. However, only perform this operation when necessary since the contents of memory are cleared by resetting.

5-7. ORDERING SPARE PARTS

When ordering replacement or spare parts for your equipment, be sure to specify the following: Model and serial number of your transceiver. Schematic number of the part. Printed circuit board number on which the part is located, part number and name, if known, and quantity desired. Part numbers for most replacement parts is contained in the service manual (available as an option from your dealer).

5-8. ADJUSTMENTS

5-8-1. Cover removal

Cautions:

1. Before removing the cover, turn the DC power supply's power switch OFF and disconnect the power cable.
2. Do not pinch wiring when opening or closing cases.

Removing the covers

Remove the top cover (9 screws), filter unit cover (3 screws) and the bottom covers (8 screws) from radio.

5-8-2. Internal view

(A) Top view

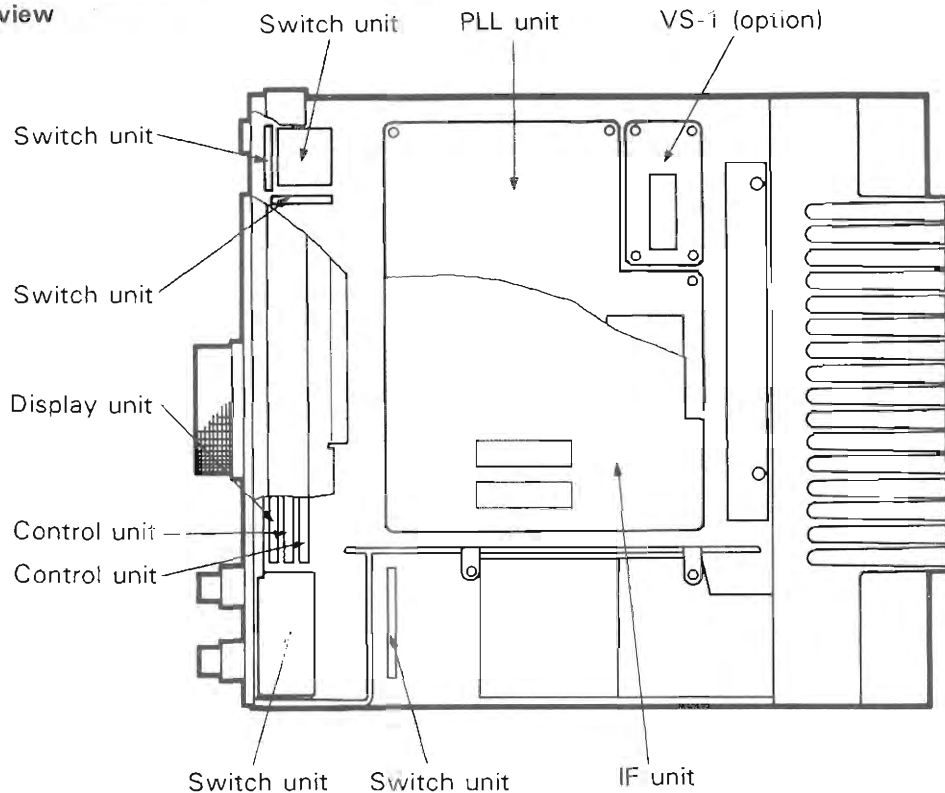

(B) Bottom view

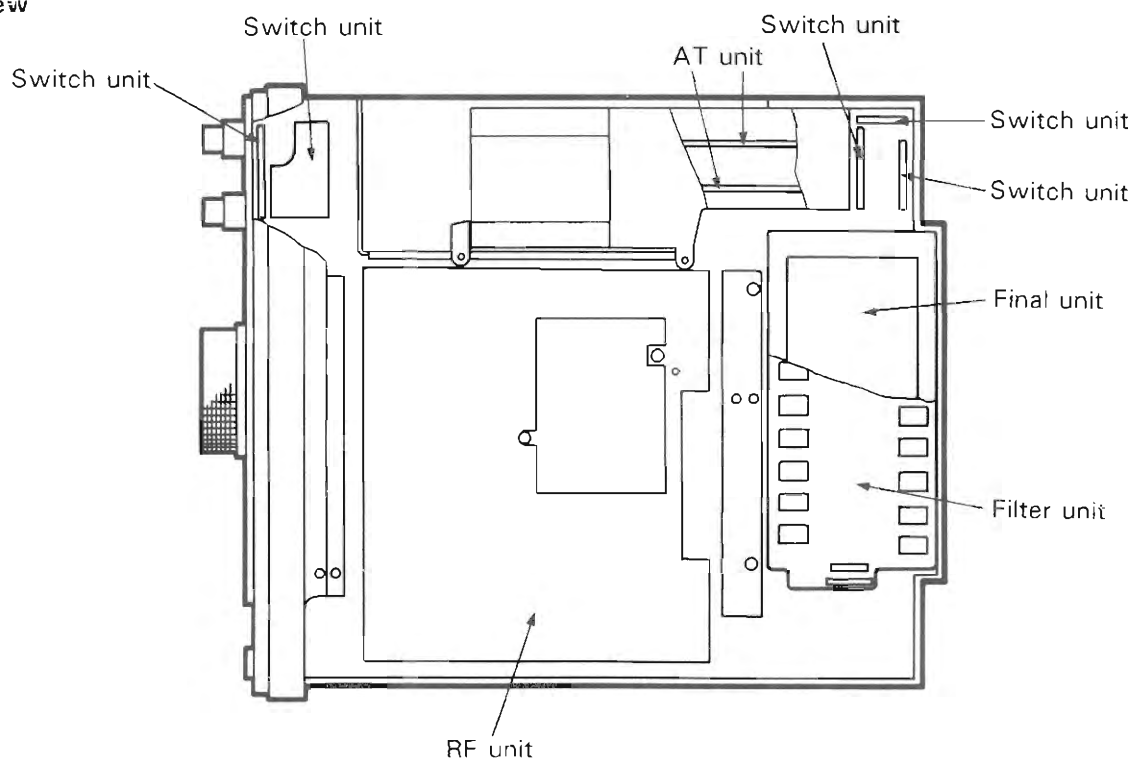

5-8-3. Digital display calibration

1. Removing the top cover, filter unit cover and the bottom covers from radio, and place the radio on its side with the antenna tuner area down.
2. Remove the two screws that secure the rear of the IF unit to the chassis and raise the IF unit up towards the front panel. Connect the two pin end of the supplied calibration cable to connector number 8 on the PLL unit, as shown in the figure.
3. Connect the single pin end of the cable to the CAL terminal pin that is located along the back edge of the RF unit, near the large shielded area.
4. Connect your antenna and tune to WWV.
5. Using a small flat bladed screwdriver adjust trimmer capacitor TC1, near connector 8 of the PLL unit, for zero beat. Zero beat is the point where the two audio tones are oscillating at the slowest rate.

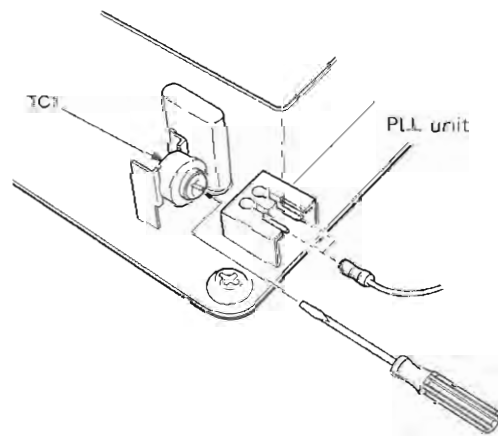
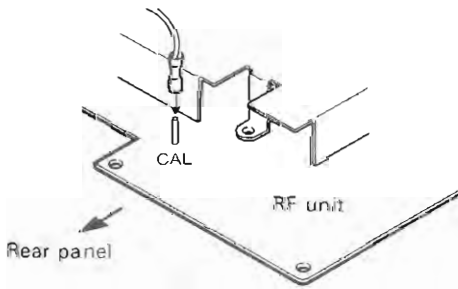
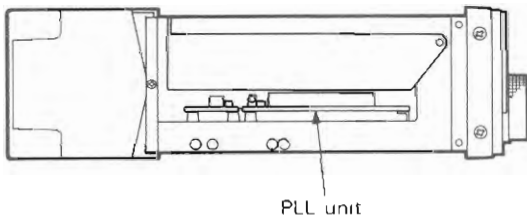

5-8-4. Optional 10 Hz display resolution

If you would like 10 Hz resolution instead of the supplied 100 Hz display resolution, cut D66 as shown on the Control unit.

1. Remove the top and bottom covers from the radio.
2. Remove the countersink screws (2 on each side) that secure the front panel to the chassis and gently pull the front panel forwards.
3. Remove the 5 small round head screws that secure the shield plate (2 on the top and 3 on the bottom) to the front panel, and remove the shield plate.
4. Cut the lead of diode D66 located below the dip switch on the control unit.
5. Reverse steps 1. – 3. to reassemble the radio.

Notes:

1. When reassembling the radio make sure that you do not cut or pinch any wires between the chassis and front panel!
2. Do not alter the settings of the dip switch. They are factory adjusted, and damage or misoperation may result.

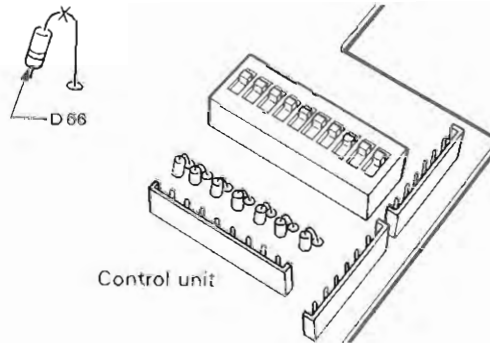

5-8-5. CW zero beat frequency selection

You may select between 800 Hz and 400 Hz zero beat adjustments in the CW mode by cutting diode D73 on the control unit.

1. Remove the top and bottom covers from the radio.
2. Remove the countersink screws (2 on each side) that secure the front panel to the chassis and gently pull the front panel forwards.
3. Remove the 5 small round head screws that secure the shield plate (2 on the top and 3 on the bottom) to the front panel, and remove the shield plate.
4. Cut the lead of diode D73 located below the dip switch on the control unit.
5. Reverse steps 1. – 3. to reassemble the radio.

Notes:

1. When reassembling the radio make sure that you do not cut or pinch any wires between the chassis and front panel!
2. Do not alter the settings of the dip switch. They are factory adjusted, and damage or misoperation may result.

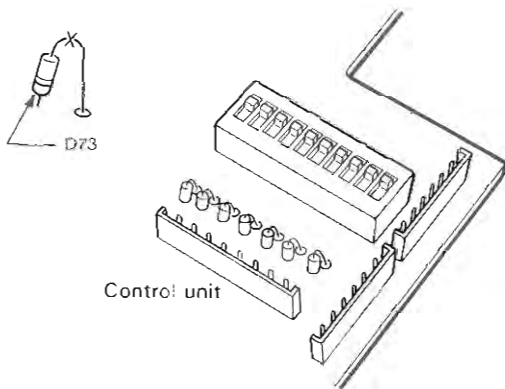

4. Cut the lead of diode D65 located below the dip switch on the control unit.
5. Reverse steps 1. - 3. to reassemble the radio.

Notes:

1. When reassembling the radio make sure that you do not cut or pinch any wires between the chassis and front panel!
2. Do not alter the settings of the dip switch. They are factory adjusted, and damage or misoperation may result.

5-8-6. Side tone level

1. Remove the top cover.
2. Adjust VR-9 for your reference.
3. Replace the top cover.

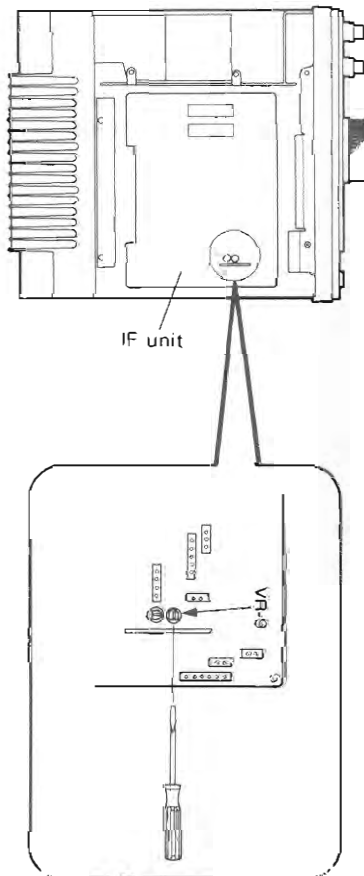
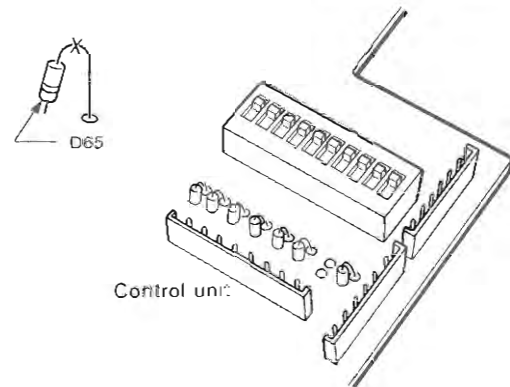

5-8-8. Beep tone level:

1. Remove the top cover.
2. Adjust VR-10 for your reference.
3. Replace the top cover.

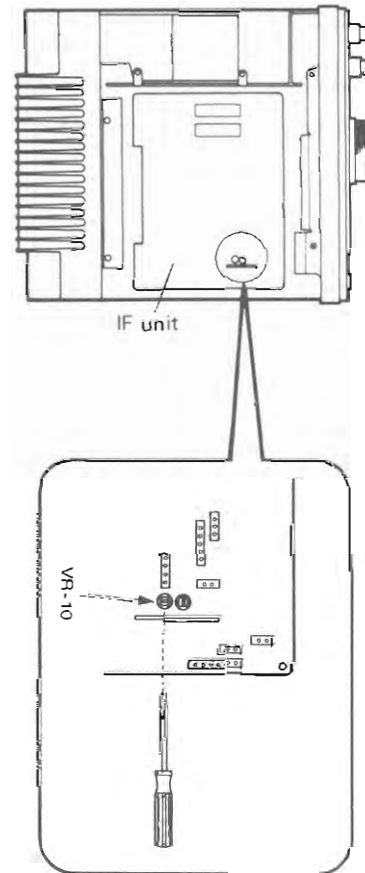

5-8-7. Beep tone selection

The audio oscillator that provides the Morse Code signal when you press a mode key may be changed to provide only a single confirmation tone by cutting diode D65 on the Control unit.

1. Remove the top and bottom covers from the radio.
2. Remove the countersink screws (2 on each side) that secure the front panel to the chassis and gently pull the front panel forwards.
3. Remove the 5 small round head screws that secure the shield plate (2 on the top and 3 on the bottom) to the front panel, and remove the shield plate.

5-8-9. TUNING dial torque

Turn the VFO knob while holding the silver ring. As the VFO knob is turned clockwise, drag will be increased.

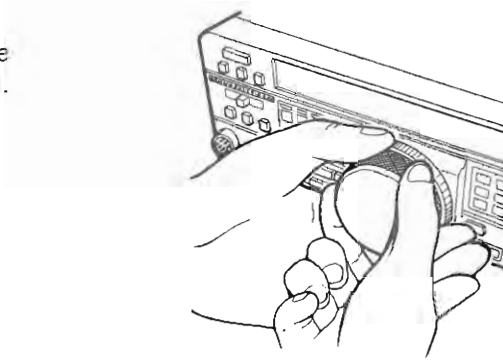

5-8-10. Linear amplifier control

As delivered from the factory, the external keying relay for control of a linear amplifier is disabled. If you want to connect a linear amplifier connect the jumper wire on the Switch unit to the ON terminal as shown in the accompanying figure.

Note: The control relay functions only when the jumper wire on board X41-1610-N/14 is connected to the ON position.

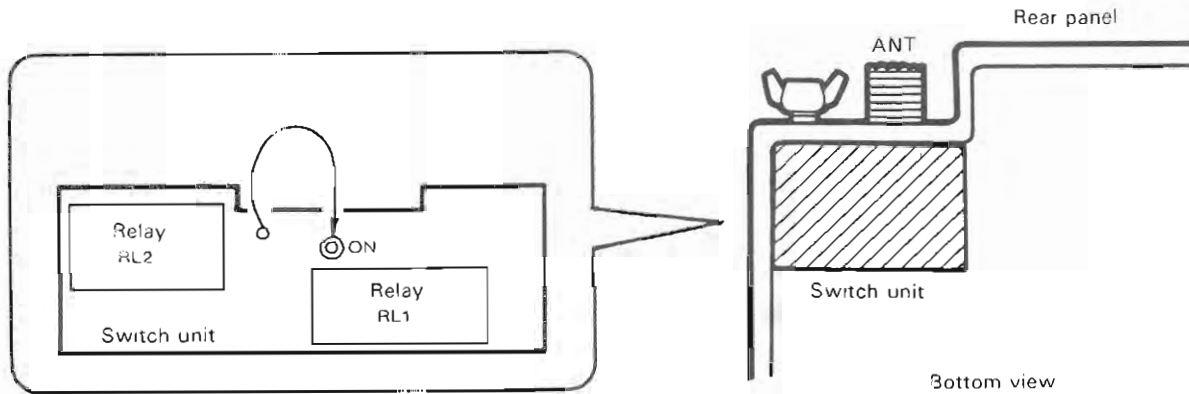

6. OPTIONAL ACCESSORIES

The following accessories are available for more sophisticated operation of your transceiver.

6-1. CRYSTAL FILTER INSTALLATION

1. Remove the top cover from the radio. Be careful of the speaker lead, which may be unplugged.
2. Remove the seven screws securing the IF unit to the chassis.
3. Install the crystal filter in the appropriate location on the IF unit. The SSB filter goes towards the center and the CW filter towards the edge of the board. Solder the filter in place, and cut off the excess lead lengths.

Note:

When soldering use a low wattage iron (40 watts or less), and a high quality rosin core solder. Do not use acid core solder as this will eventually cause damage to the circuit board. Solder quickly, but ensure that you have a good solder connection. If the connection is dull, or looks crystalized you will have to remove the solder and try again.

4. When installing the optional crystal filter, move the white or blue lead, or both to the appropriate terminal as shown in the chart on page 28.
5. Replace the IF unit and secure with the seven screws removed in step 2.
6. Reattach the speaker lead, and replace the top cover.

Note:

Two terminals are provided for the WIDE and SSB jumper. Either of the two terminals may be used.

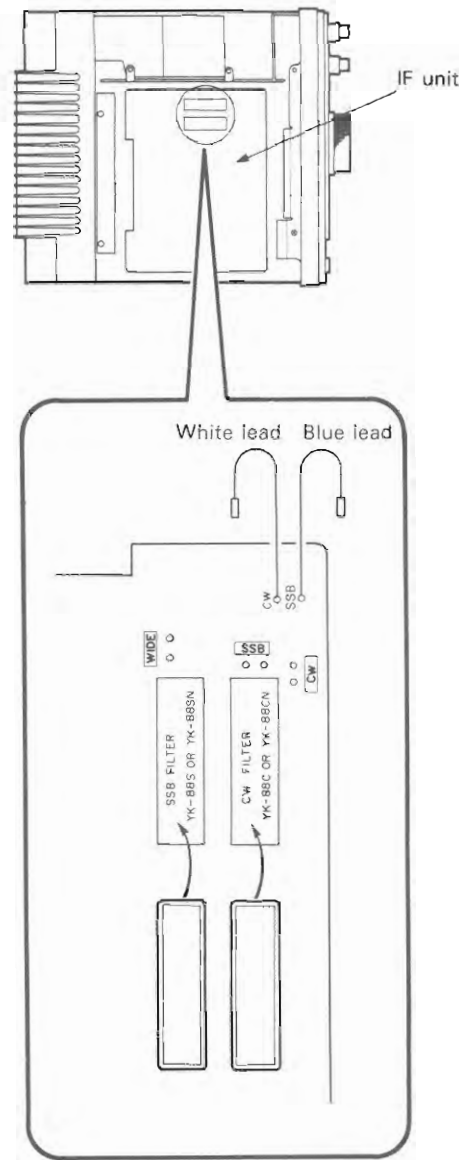

■ **YK-88C CW FILTER**

Center frequency : 8,830.7 kHz
 Passband width : 500 Hz (-6 dB)
 Attenuation bandwidth : 1.5 kHz (-60 dB)
 Guaranteed attenuation : More than 80 dB

■ **YK-88CN CW NARROW FILTER**

Center frequency : 8,830.7 kHz
 Passband width : 270 Hz (-6 dB)
 Attenuation bandwidth : 1.1 kHz (-60 dB)
 Guaranteed attenuation : More than 80 dB

■ **YK-88SN SSB NARROW FILTER**

Center frequency : 8,830.0 kHz
 Passband width : 1.8 kHz (-6 dB)
 Attenuation bandwidth : 3.3 kHz (-60 dB)
 Guaranteed attenuation : More than 80 dB

■ **YK-88S SSB FILTER**

Center frequency : 8,830.0 kHz
 Passband width : 2.4 kHz (-6 dB)
 Attenuation bandwidth : 4.2 kHz (-60 dB)
 Guaranteed attenuation : More than 80 dB



YK-88C



YK-88CN



YK-88SN

OPTIONAL CRYSTAL FILTER COMBINATION	SELECTIVITY POSITION	MODE					Terminal connection		
		USB	LSB	C W	FSK	A M	FM	White lead	Blue lead
No optional filter	AUTO	2.2 kHz			6 kHz		12 kHz	WIDE	WIDE
	N	No sound from the speaker							
	M1								
	M2	2.2 kHz			6 kHz				
YK-88S	W	6 kHz							
	AUTO	2.1 kHz			6 kHz		12 kHz	SSB	SSB
	N	No sound from the speaker							
	M1	2.1 kHz			6 kHz				
M2	2.2 kHz			6 kHz					
YK-88SN	W	6 kHz							
	AUTO	1.8 kHz			6 kHz		12 kHz	SSB	SSB
	N	No sound from the speaker							
	M1	1.8 kHz			6 kHz				
M2	2.2 kHz			6 kHz					
YK-88C	W	6 kHz							
	AUTO	2.2 kHz	500 Hz		6 kHz	12 kHz	CW	WIDE	
	N	500 Hz							
	M1	No sound from the speaker							
M2	2.2 kHz			6 kHz					
YK-88CN	W	6 kHz							
	AUTO	2.2 kHz	270 Hz		6 kHz	12 kHz	CW	WIDE	
	N	No sound from speaker							
	M1	2.2 kHz			6 kHz				
M2	2.2 kHz			6 kHz					
YK-88S and YK-88C	W	6 kHz							
	AUTO	2.1 kHz	500 Hz		6 kHz	12 kHz	CW	SSB	
	N	500 Hz							
	M1	2.1 kHz			6 kHz				
M2	2.2 kHz			6 kHz					
YK-88S and YK-88CN	W	6 kHz							
	AUTO	2.1 kHz	270 Hz		6 kHz	12 kHz	CW	SSB	
	N	270 Hz							
	M1	2.1 kHz			6 kHz				
M2	2.2 kHz			6 kHz					
YK-88SN and YK-88C	W	6 kHz							
	AUTO	1.8 kHz	500 Hz		6 kHz	12 kHz	CW	SSB	
	N	500 Hz							
	M1	1.8 kHz			6 kHz				
M2	2.2 kHz			6 kHz					
YK-88SN and YK-88CN	W	6 kHz							
	AUTO	1.8 kHz	270 Hz		6 kHz	12 kHz	CW	SSB	
	N	270 Hz							
	M1	1.8 kHz			6 kHz				
M2	2.2 kHz			6 kHz					
YK-88C and YK-88CN	W	6 kHz							
	AUTO	500 Hz	270 Hz		6 kHz	12 kHz	CW	SSB	
	N	270 Hz							
	M1	500 Hz			6 kHz				
M2	2.2 kHz			6 kHz					
YK-88C and YK-88CN	W	6 kHz							

6-2. VOICE SYNTHESIZER UNIT VS-1 INSTALLATION

1. Remove the top cover from the radio.
2. Remove the two screws on the rear of the IF unit and raise the unit to allow access to the PLL unit.
3. Install the VS-1 in the area at the left rear of the PLL unit using the three screws provided with the VS-1.
4. Install the 3-pin plug on connector J01 and the 8-pin plug on connector J02.
5. Select the desired language that you want with switch S-1 on the VS-1. ENG for English, or JA for Japanese.
6. Install the 4-pin plug on connector ③ 05 the IF unit.
7. Reverse step 1.—2.
8. Turn on the power switch and press the VOICE switch. The frequency will be announced. Adjust VR-1 for the desired audio output level.

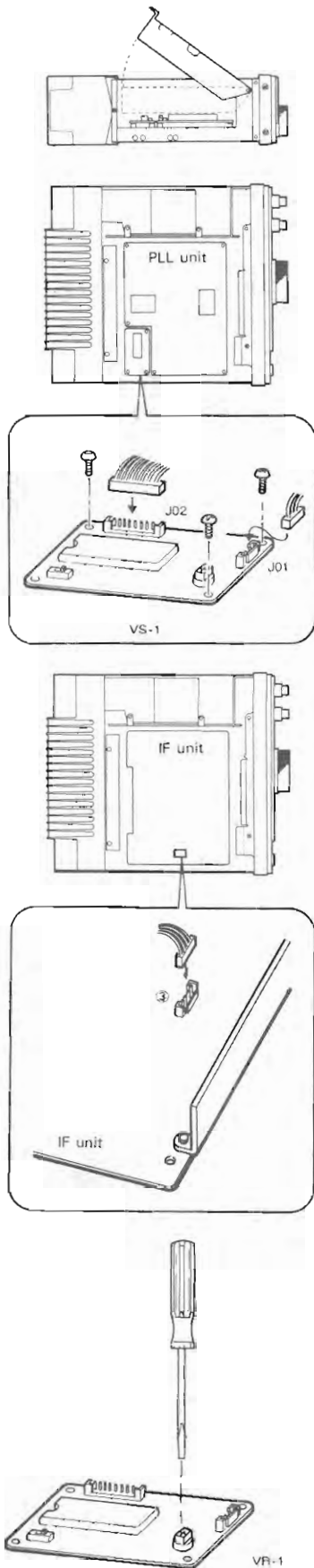

6-3. INTERFACE IC KIT IC-10 INSTALLATION

Installing the optional IC-10 kit will allow control of the radio from a personal computer. The following operations are possible:

- Programming and recall of VFO A and VFO B frequency
- MR (Memory Recall) and M.IN (Memory Input)
- Microphone UP/DOWN frequency control disable
- Control of the F.LOCK switch
- Memory channel selection
- MODE selection
- Control of RIT/XIT
- Selection of RIT/XIT frequency
- Scan operation
- Review of transceiver status

6-3-1. Installation

1. Remove the top and bottom covers from the radio.
2. Remove the countersink screws (2 on each side) that secure the front panel to the chassis and gently pull the front panel forwards.
3. Remove the 5 small round head screws that secure the shield plate (2 on the top and 3 on the bottom) to the front panel, and remove the shield plate.
4. Install the IC's into the vacant sockets on the Control unit. Orientation of this component is critical for proper operation of the radio, and interface.

Caution:

Install the IC's so that the notch in the end is on the same end as the notch in the IC socket.

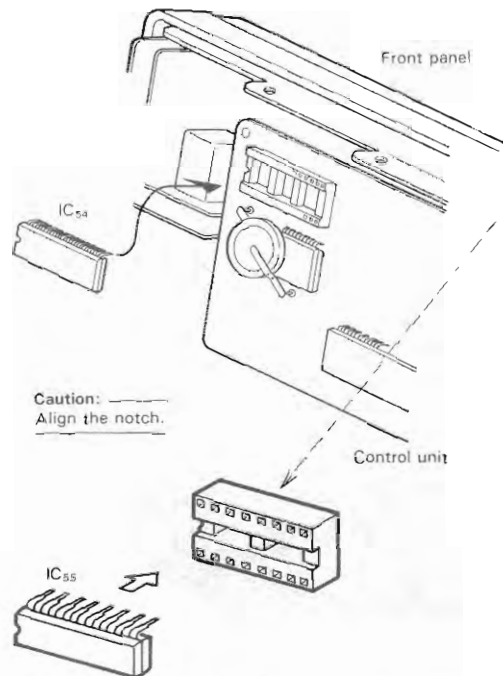

IC₅₄ : μ PD8251AC (NEC) or equivalent
 IC₅₅ : TC4040BP (Toshiba) or equivalent

5. Reverse steps 1.—3. to reassemble the radio.

Caution:

Do not pinch and stretch any wires.

6-3-2. Operation

Refer to the instruction manual provided with the IC-10 Interface IC Kit.

6-4. OTHER ACCESSORIES

■ PS-50 HEAVY DUTY DC POWER SUPPLY

Designed to match the TS-440S. Supplies regulated 13.8 VDC at 20 A with built-in cooling fan and protection circuits for maximum reliability.

■ PS-430 DC POWER SUPPLY

The PS-430 is a regulated DC power supply with high current capability. The output is 13.8 VDC/20 A (intermittent). Since terminals for 13.8 VDC/10 A are also provided, in addition to an output power cable for use with the TS-440S, the PS-430 can be used as the power source for another low power mobile transceiver such as a 2-meter rig.

■ AT-440 AUTOMATIC ANTENNA TUNER UNIT

The AT-440 Automatic Antenna Tuner unit can be installed in the TS-440S. The tuner covers all amateur bands from 80 through 10 meters, including the new WARC bands. Matching capability is 20 to 150 ohms, unbalanced.

■ AT-250 AUTOMATIC ANTENNA TUNER

The AT-250 Automatic Antenna Tuner covers 160 through 10 meters bands.

■ AT-230 ANTENNA TUNER

The AT-230 Antenna Tuner covers 160 through 10 meters bands.

■ AT-130 ANTENNA TUNER

The AT-130 Antenna Tuner covers 80 through 10 meters bands.

■ MC-85 MICROPHONE (8-pin)

The MC-85 is a unidirectional high-class electret condenser microphone provided with the output selective switch, audio level compensation circuit, low cut filter, level meter, PTT and LOCK switches. An 8-pin cable is provided, with optional cables, up to three outputs are possible.

■ MC-80 MICROPHONE (8-pin)

The MC-80 is an omnidirectional electret condenser microphone provided with UP/DOWN switches, volume adjustment for output level, PTT and LOCK switches, built-in pre-amplifier.

■ MC-60A MICROPHONE (8-pin)

The zinc die-cast base provides high stability, and the MC-60A is complete with PTT and LOCK switches, UP/DOWN switches, and impedance selector switch and a built-in pre-amplifier.

■ MC-55 MOBILE MICROPHONE (8-pin)

The MC-55 provides UP/DOWN switches, LED display for switching transmit or receive, adjustable microphone gain, automatic receive returning circuit (approx. 5 minutes) and many functions.

■ MC-42S UP/DOWN HAND MICROPHONE

The MC-42S is handy dynamic microphone with PTT switch and UP/DOWN switches.

■ LF-30A LOW PASS FILTER



PS-50

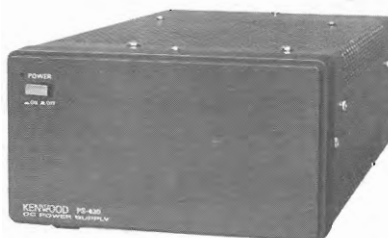

PS-430



AT-250



MC-85

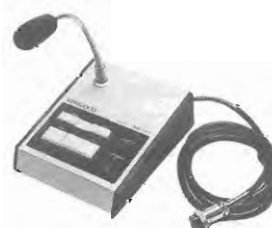

MC-80



MC-60A



MC-55



MC-42S

■ **MB-430 MOBILE MOUNT**

The Mobile Mount MB-430 allows easy installation and removal of the TS-440S. The MB-430 can either be suspended from the dashboard or attached to the transmission tunnel or a center console. The transceiver tilt angle can be adjusted 5 steps.

■ **PG-2C DC POWER CABLE**

■ **MA-5 5 BAND HELICAL TYPE HF MOBILE ANTENNA**

■ **VP-1 BUMPER MOUNT FOR MA-5**

■ **SP-430 EXTERNAL SPEAKER**

The SP-430 is an attractive, compact external speaker. This low-distortion speaker provides clear reproduction of the high-quality audio obtained from the transceiver.

■ **SP-50 MOBILE SPEAKER (8 ohms)**

Compact and smart high quality external speaker provides flexibility of installation for maximum convenience.

■ **SP-41 COMPACT MOBILE SPEAKER (4 ohms)**

■ **TL-922A/TL-922 HF LINEAR AMPLIFIER**

(Not for QSK operation.)

The TL-922A/922 is an HF linear amplifier operating at maximum legal power, and employing a pair of 3-500Z high performance transmitting tubes. TL-922A (without 10 meter band) is available only in U.S.A.

■ **SM-220 STATION MONITOR**

Built around a basic 10 MHz oscilloscope, the SM-220 station monitor features, in combination with a built-in two-tone generator, a variety of waveform-observing capabilities.

■ **PC-1A PHONE PATCH**

(Available only where phone patch operation legal.)

Hybrid phone patch with VU meter for null and audio gain measurements. The PC-1A Phone Patch provides interface between the transceiver and telephone line. Providing excellent performance, it is designed with high isolation between receive input and transmit output. Its compact design permits easy installation in a limited space. (FCC Part 68 registered)



MB-430

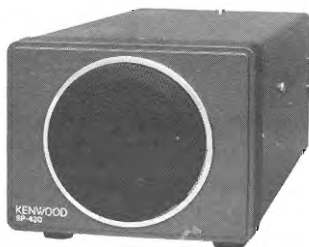

SP-430



SP-50



SP-41



SM-220



TL-922A/TL-922

■ **TU-8 SUBAUDIBLE TONE UNIT**

38 CTCSS tone frequencies can be selected by setting of the dip switch.

■ **IF-232C INTERFACE**

The IF-232C Interface is the adapter for connection between the RS-232C terminal of a personal computer and the interface terminal of the TS-440S.

■ **IC-10 INTERFACE IC KIT**

■ **SW-2000 SWR/POWER METER**

SWR/POWER meters cover 1.8 ~ 54 MHz in range of 0 ~ 200/2000 W, full scale for base station use.

■ **SW-200A SWR/POWER METER**

SW-200 A supplied with SWC-1. Selectable Peak-reading/RMS. SWR/POWER meters cover 1.8 ~ 150 MHz in range of 0 ~ 20/200 W full scale for base station use.

■ **SW-100A SWR/POWER METER**

Compact and lightweight SWR/POWER/VOLT meters cover 1.8 ~ 150 MHz in range of 150 W full scale for mobile use.

■ **HS-7 MICRO HEADPHONES (16 OHMS)**

■ **HS-6 COMMUNICATIONS HEADPHONES (12.5 OHMS)**

Deluxe, very light-weight headphones designed for communications equipment.

■ **HS-5 COMMUNICATIONS HEADPHONES (8 OHMS)**

Headphones designed for communications equipment. These light-weight open air-type headphones remain comfortable during extended operation. Easily attached earpads are provided.

■ **HS-4 COMMUNICATIONS HEADPHONES (8 OHMS)**



HS-7



HS-6



HS-5

7. BLOCK DIAGRAM

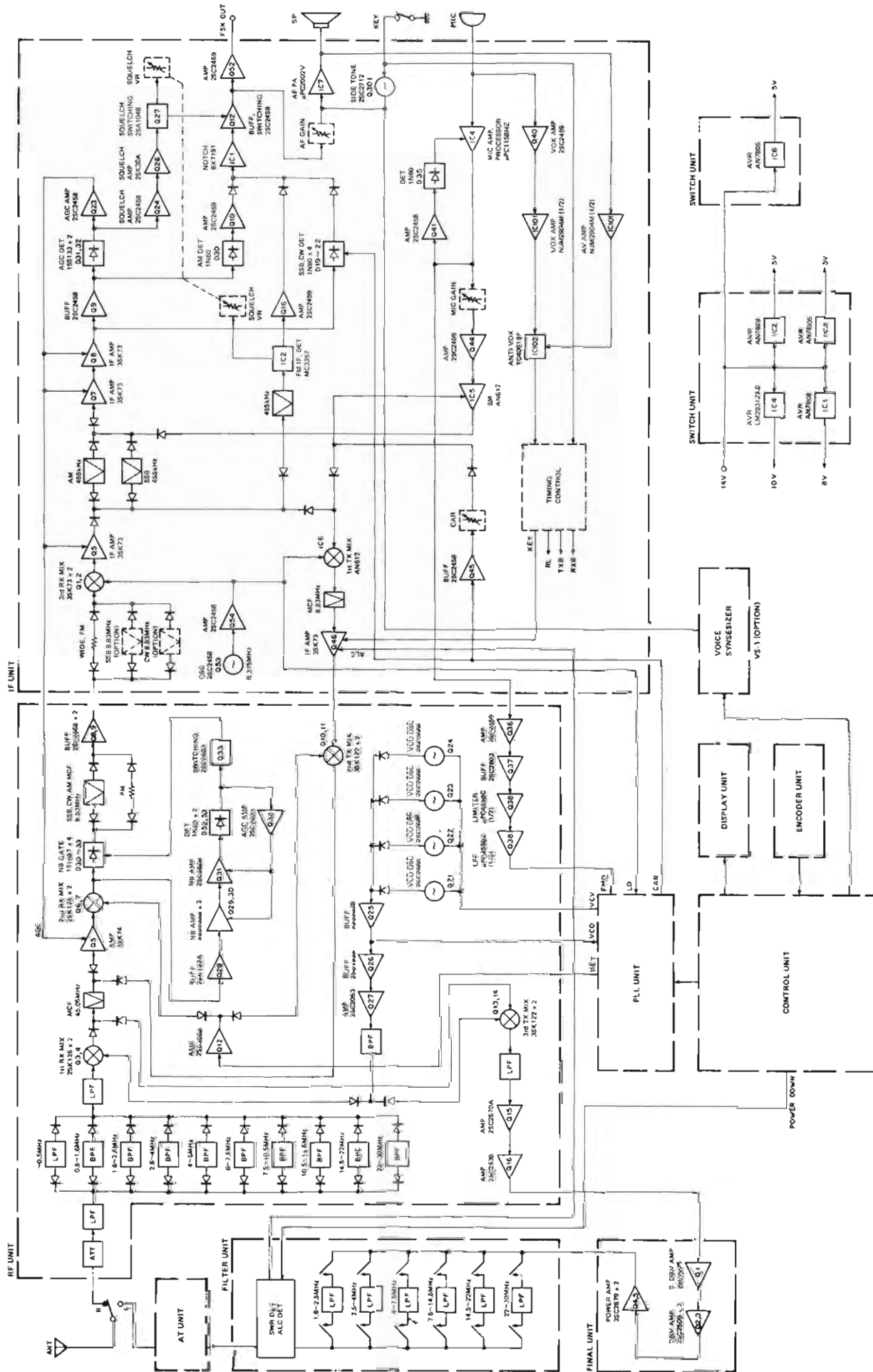

8. SCHEMATIC DIAGRAM

8-1. FILTER UNIT (X51-1340-00)/DISPLAY UNIT (X54-1870-00) (B/4)

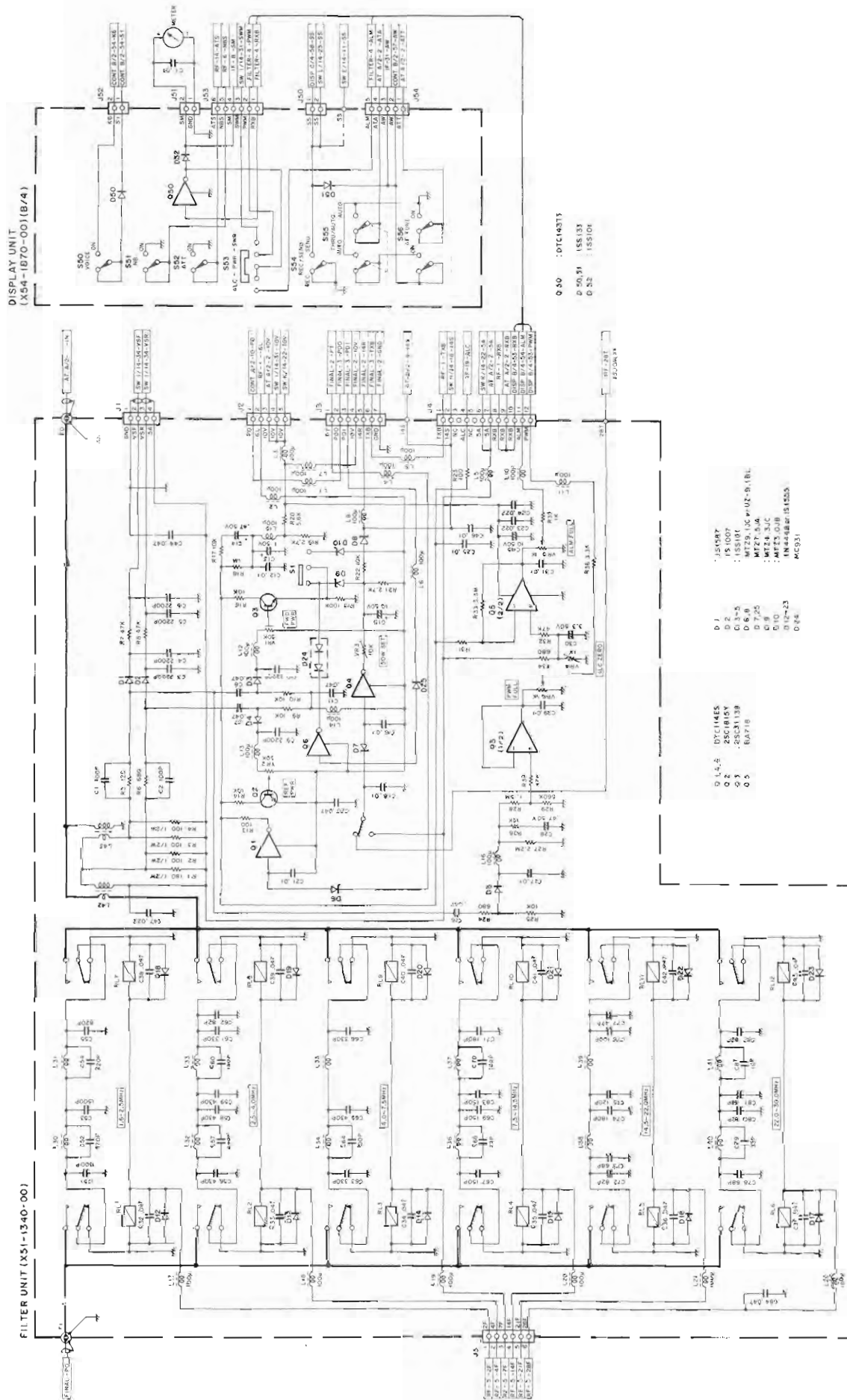

8-2. AT UNIT (X57-1150-00)

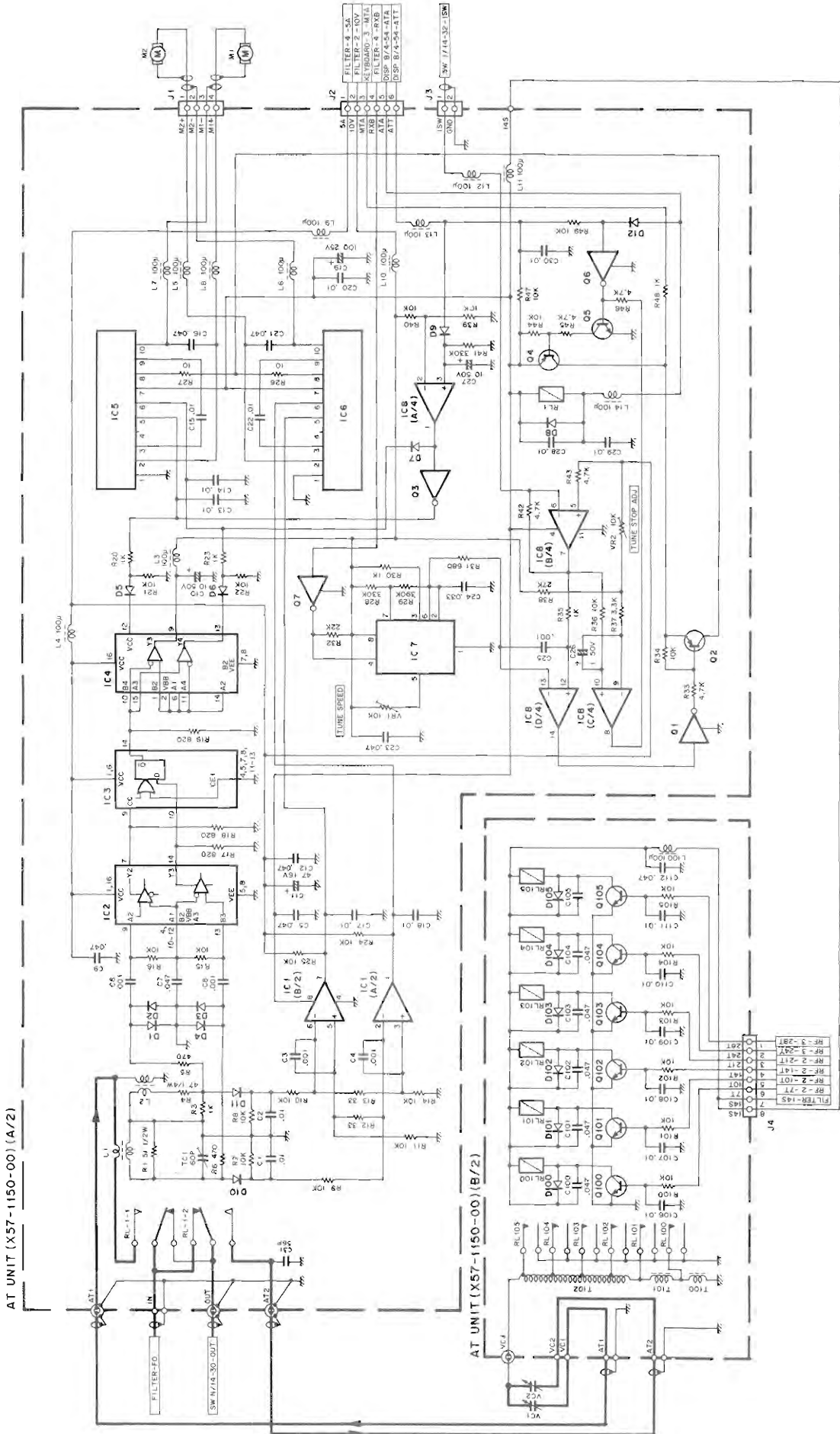

- IC 1 : NJM2903D
- IC 2 : HD1016
- IC 3 : HD1016
- IC 4 : HD1016
- IC 5,6 : 74LS14
- IC 7 : NE555P
- IC 8 : MB3614
- D 1,3,8
- D 2,9
- D 5,6
- D 7,9,12
- D 8,10,11
- D 10,11
- DTC145ES
- DTC145ES
- 2SA990(T)
- 2SC2498(T)
- DTC124ES
- 2SC2668(T)
- SS99
- U2-6.2BL
- 1S5133
- B.1,100-109 : 1S1955
- 1N60

8-3. FINAL UNIT (X54-1470-00)

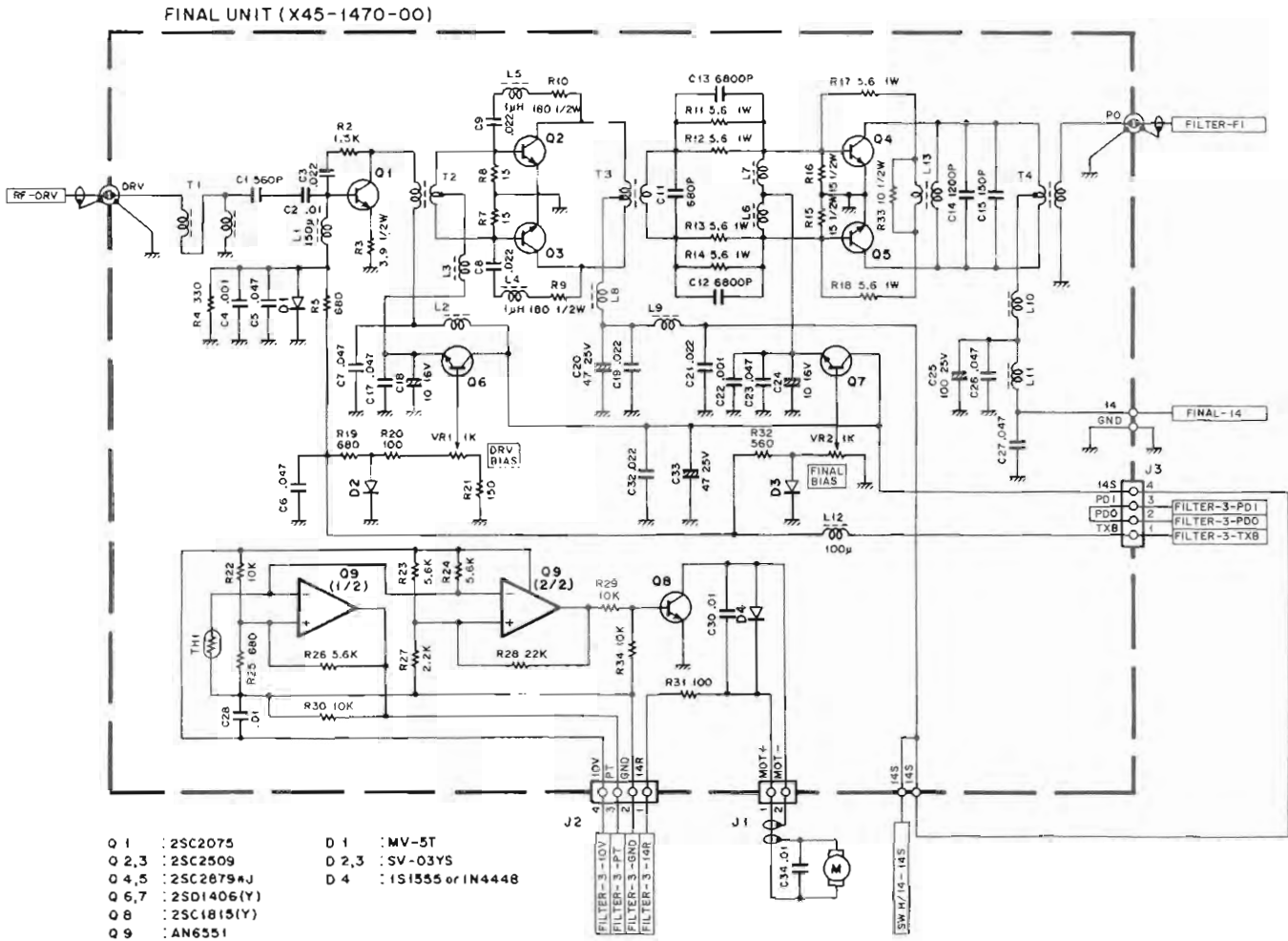

8-4. PLL UNIT (X50-2050-00)

PLL UNIT (X50-2050-00)

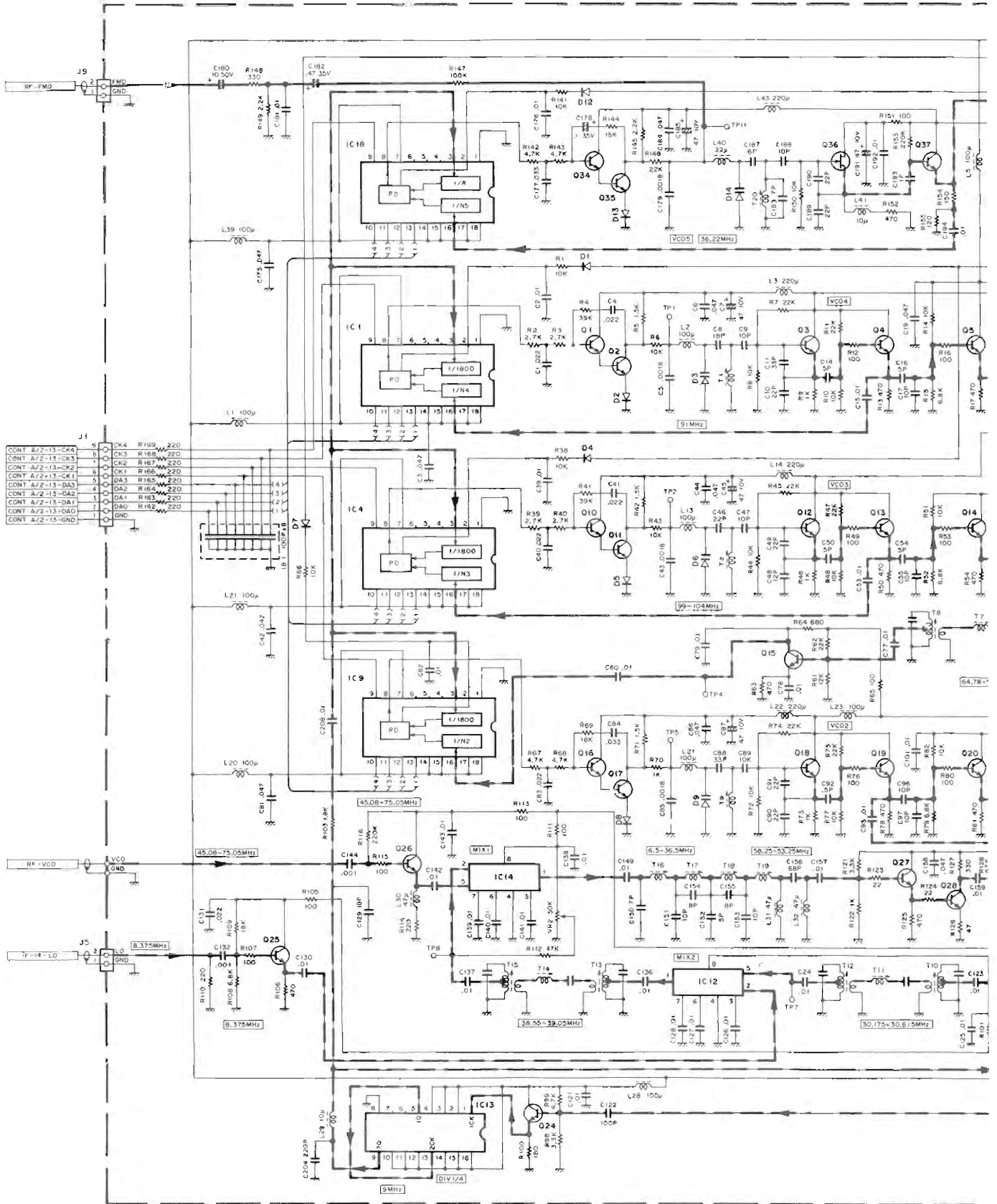

IC 1, 2	: MN6147 or MN6147C	Q 1, 2, 10, 11, 16, 17	: 2SC3113 (B)	Q 1, 2, 4, 5, 7, 8, 10, 12	: 1SS133
IC 2	: M54459L	Q 3 ~ 5, 12 ~ 15, 18 ~ 20, 22 ~ 24, 26 ~ 30,	37, 38	Q 3	: 1SV53A
IC 3, 6	: SN74LS90N	Q 6, 7, 9, 25	: 2SC2668 (Y)	Q 6, 9	: 1TT310TE
IC 7, 8, 11, 12, 14	: SN16913P	Q 8	: 2SC2458 (Y)	Q 11	: MV13
IC 5, 10	: M54460L	Q 8	: 2SC1959 (Y)	Q 13	: MV203
IC 13, 16	: SN74S12N	Q 21	: 2SC2787 (IL)	Q 14	: 1SV153
IC 15	: SN74S10N	Q 31 ~ 35	: 2SC2459 (BL)		
IC 17	: M887006	Q 36	: 2SK192A (GR)		
IC 9, 18	: MN6147				

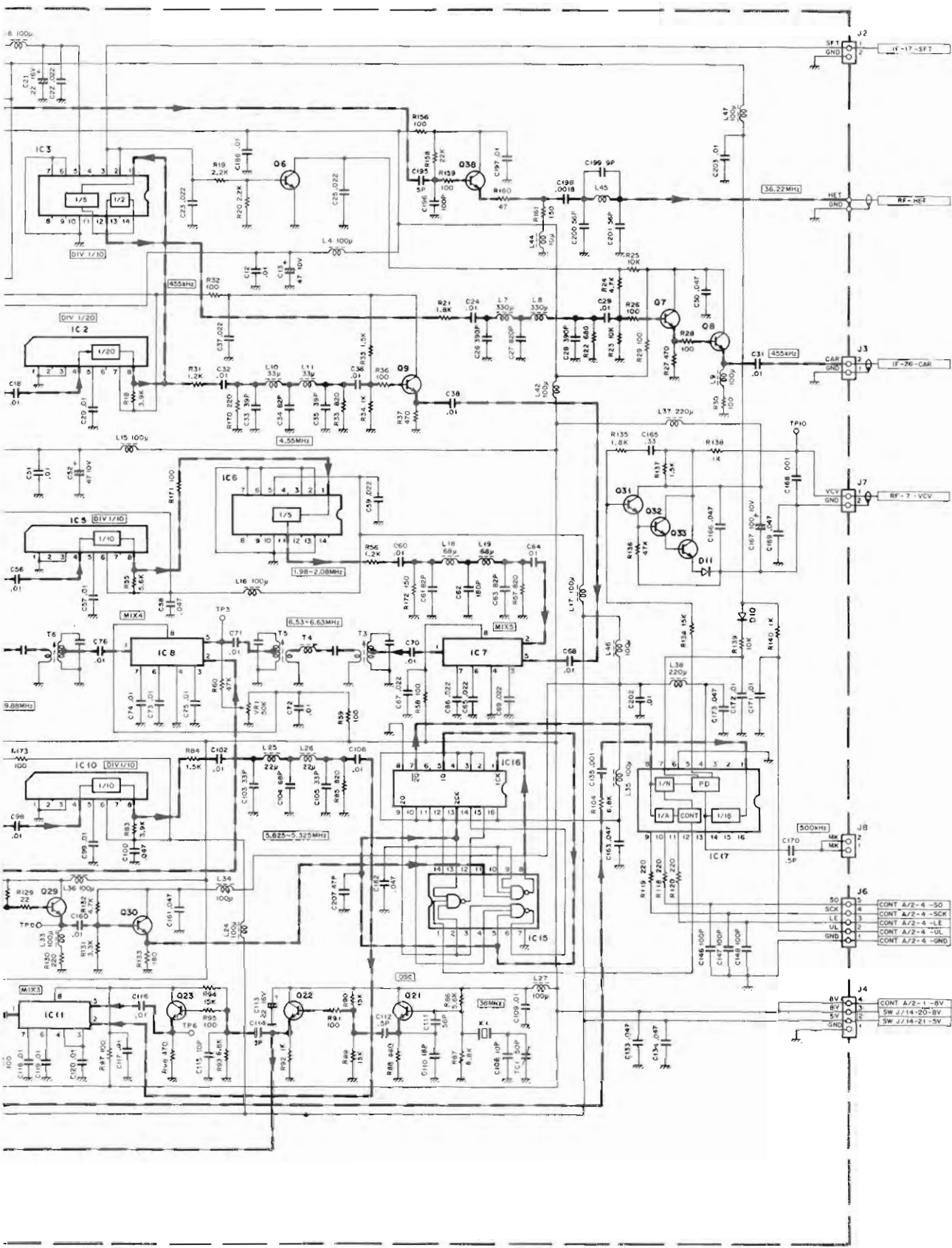

- J6
- 50
- SCA
- UL
- 1
- GND
- CONT A/2-4-50
- CONT A/2-4-SCK
- CONT A/2-4-LE
- CONT A/2-4-101
- CONT A/2-4-GND

- J4
- 8V
- 5V
- 5V
- GND
- CONT A/2-1-8V
- SW J/14-20-8V
- SW J/14-21-5V

8-5. RF UNIT (X44-1680-00)

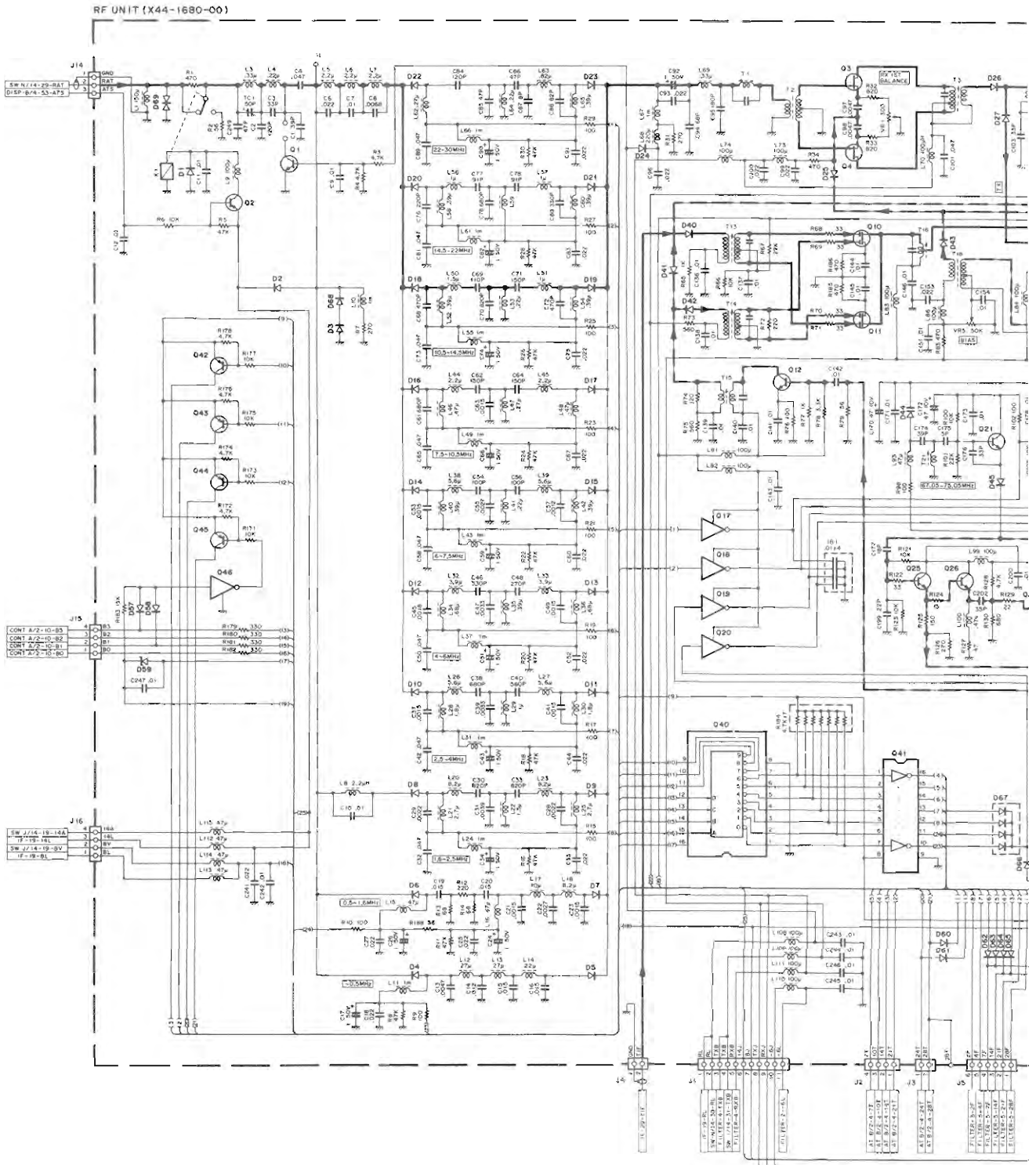

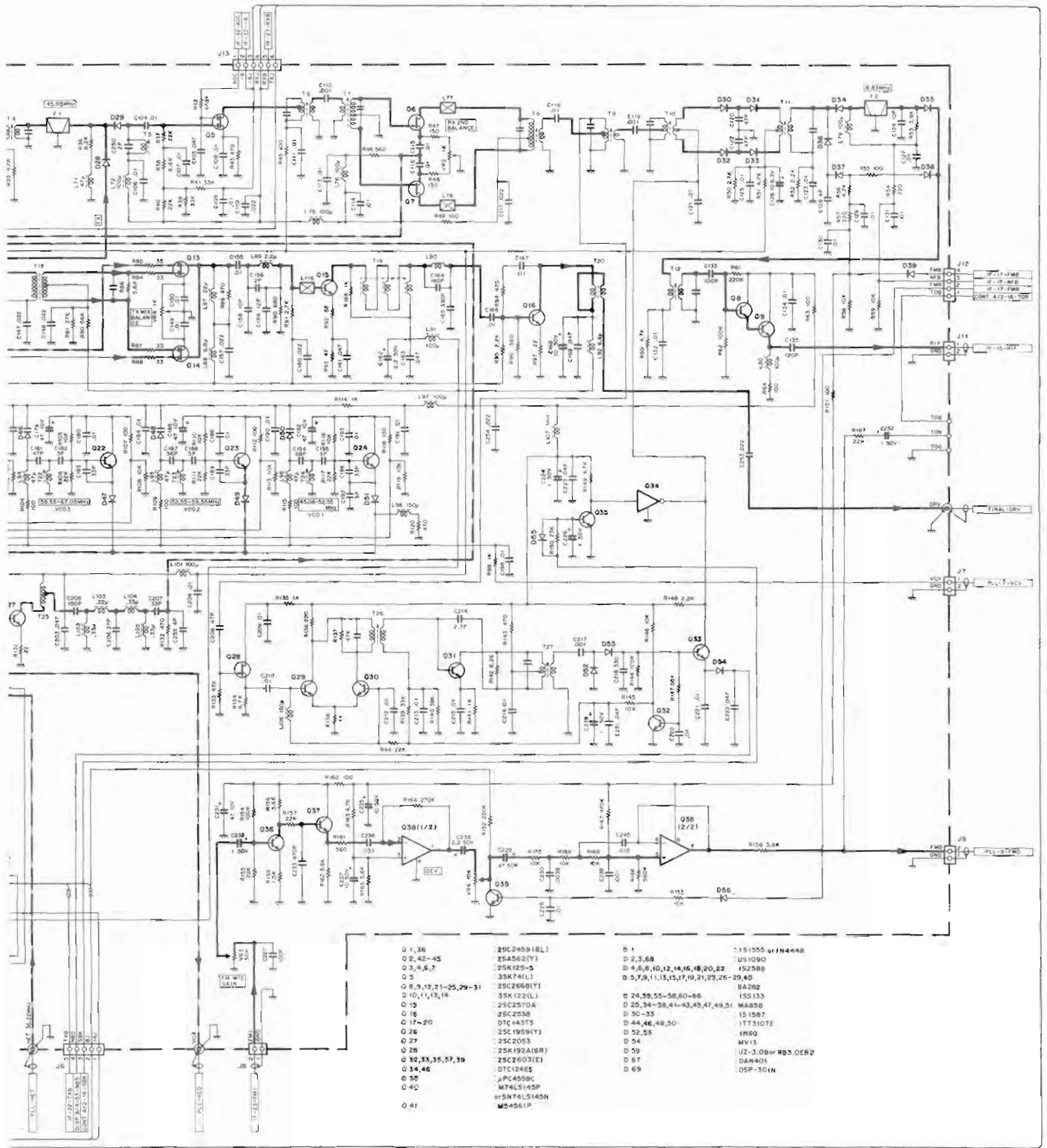

- | | | | |
|--------------------------|--------------|--|---------------------|
| D 1, 36 | 20C2459 (BL) | D 1 | 1S1555 or 1N4448 |
| D 2, 42-45 | 25A562(Y) | D 2, 3, 6, 8 | US1090 |
| D 3, 4, 5, 7 | 25K125-S | D 4, 5, 6, 10, 12, 14, 16, 18, 20, 22 | 4S2586 |
| D 5 | 35K74(L) | D 5, 7, 9, 11, 13, 15, 17, 19, 21, 23, 26-29, 40 | BA209 |
| D 6, 9, 12, 21-25, 29-31 | 25C266(Y) | D 24, 35, 55-58, 60-66 | 1S5133 |
| D 10, 11, 13, 14 | 35K122(L) | D 25, 34-38, 41-43, 45, 47, 49, 51 | MA858 |
| D 15 | 25C2570A | D 30-33 | 1S1587 |
| D 16 | 25C2538 | D 44, 46, 48, 50 | 1T7310TE |
| D 17-20 | DT1443(S) | D 52, 55 | (M6) |
| D 26 | 25C1959(Y) | D 54 | MV13 |
| D 27 | 25C2053 | D 59 | UZ-3.08 or R03.0E8V |
| D 28 | 25K192A(GR) | D 67 | DAN401 |
| D 32, 33, 35, 37, 39 | 25C2603(E) | D 68 | OSP-30IN |
| D 34, 46 | DT124(E) | | |
| D 38 | PC455BC | | |
| D 40 | M74LS145P | | |
| D 41 | SN74LS145N | | |
| | M54561P | | |

8-6. CONTROL UNIT (X53-1450-00)/DISPLAY UNIT (X54-1870-00) (A/4)

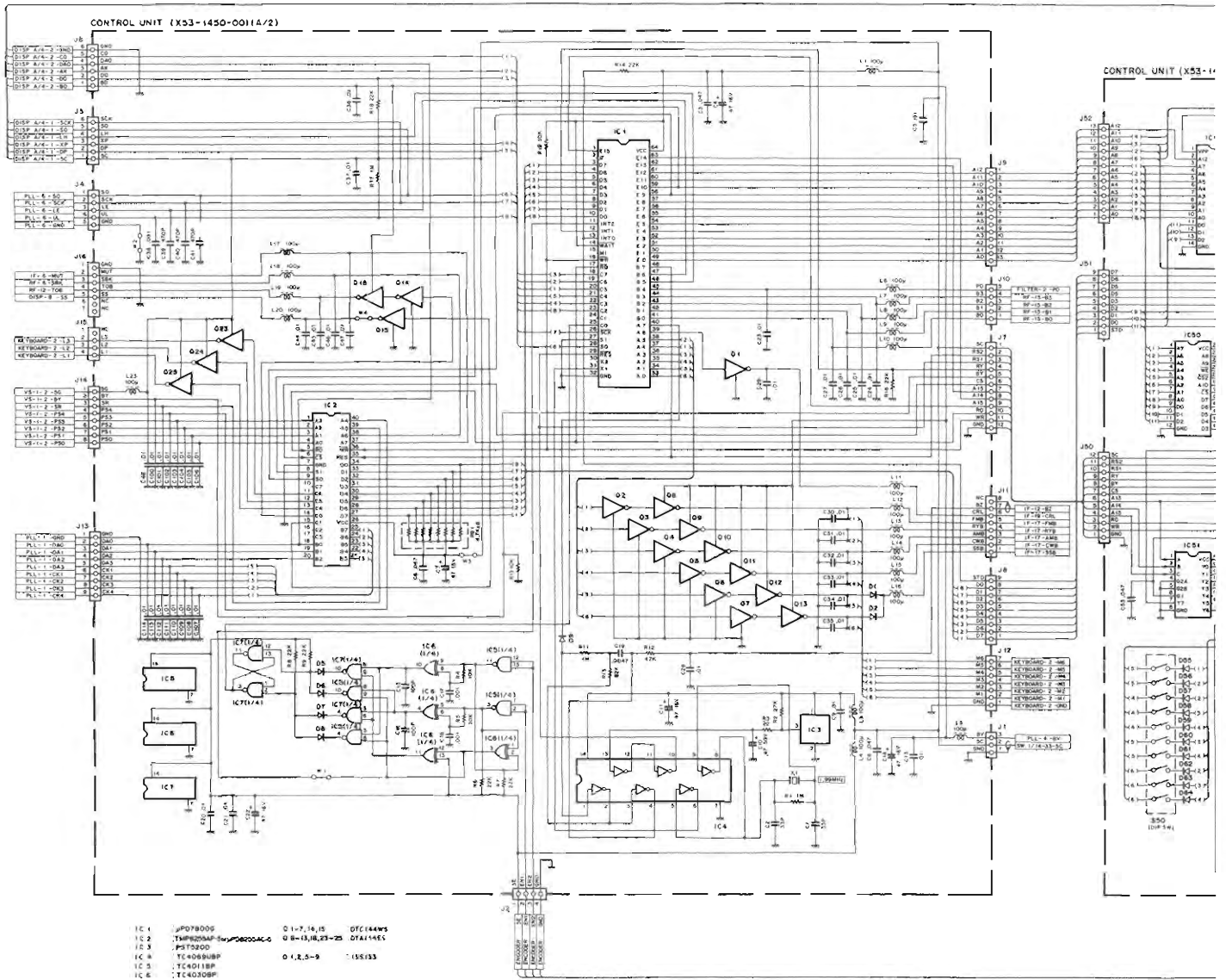

8-7. IF UNIT (X60-1300-00)

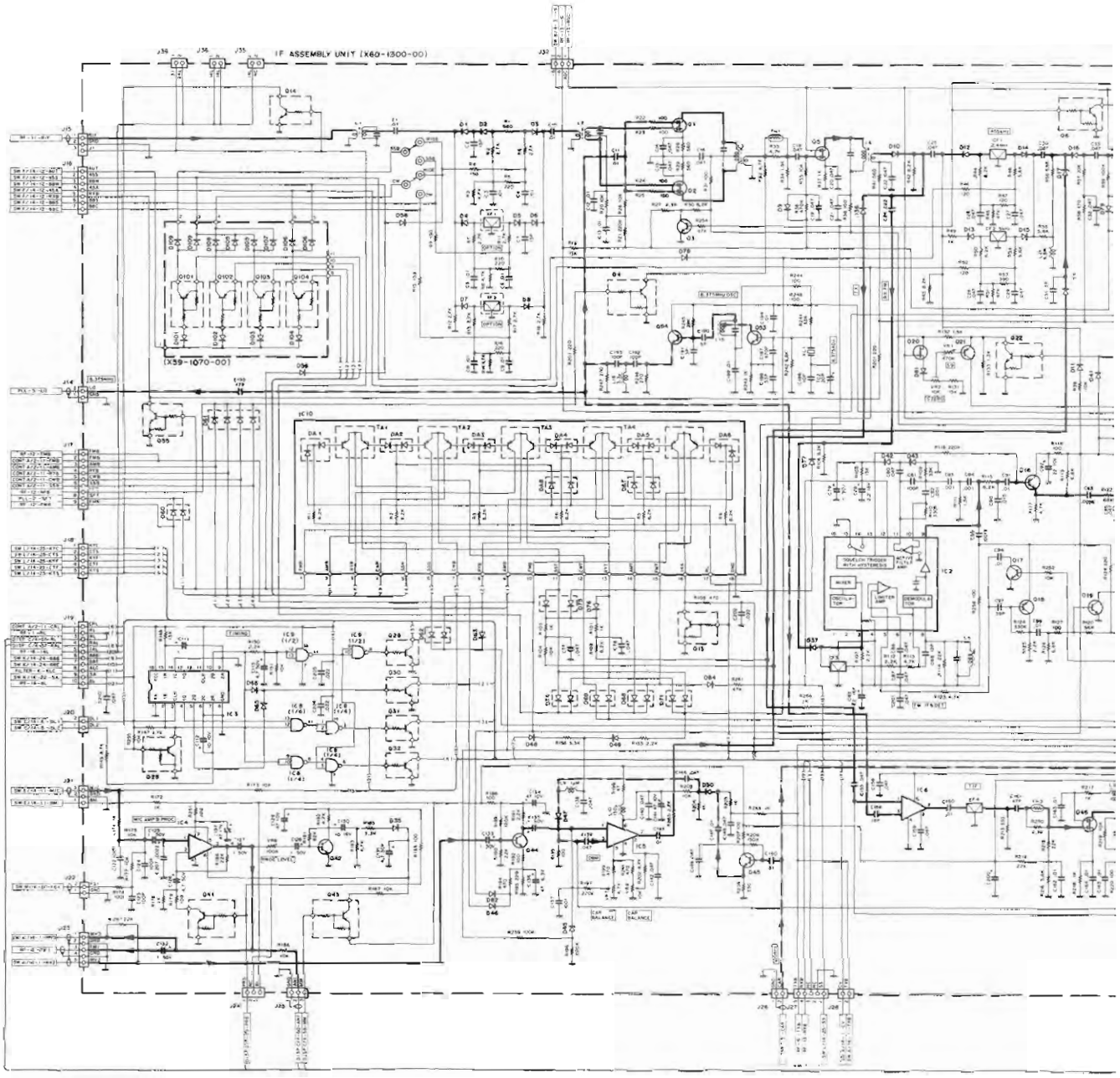

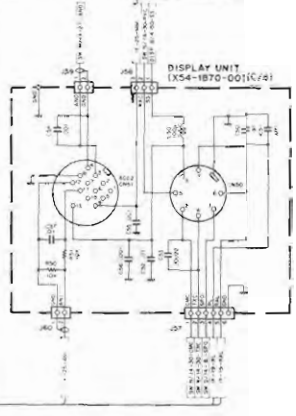
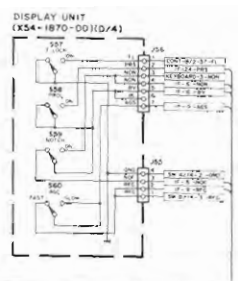
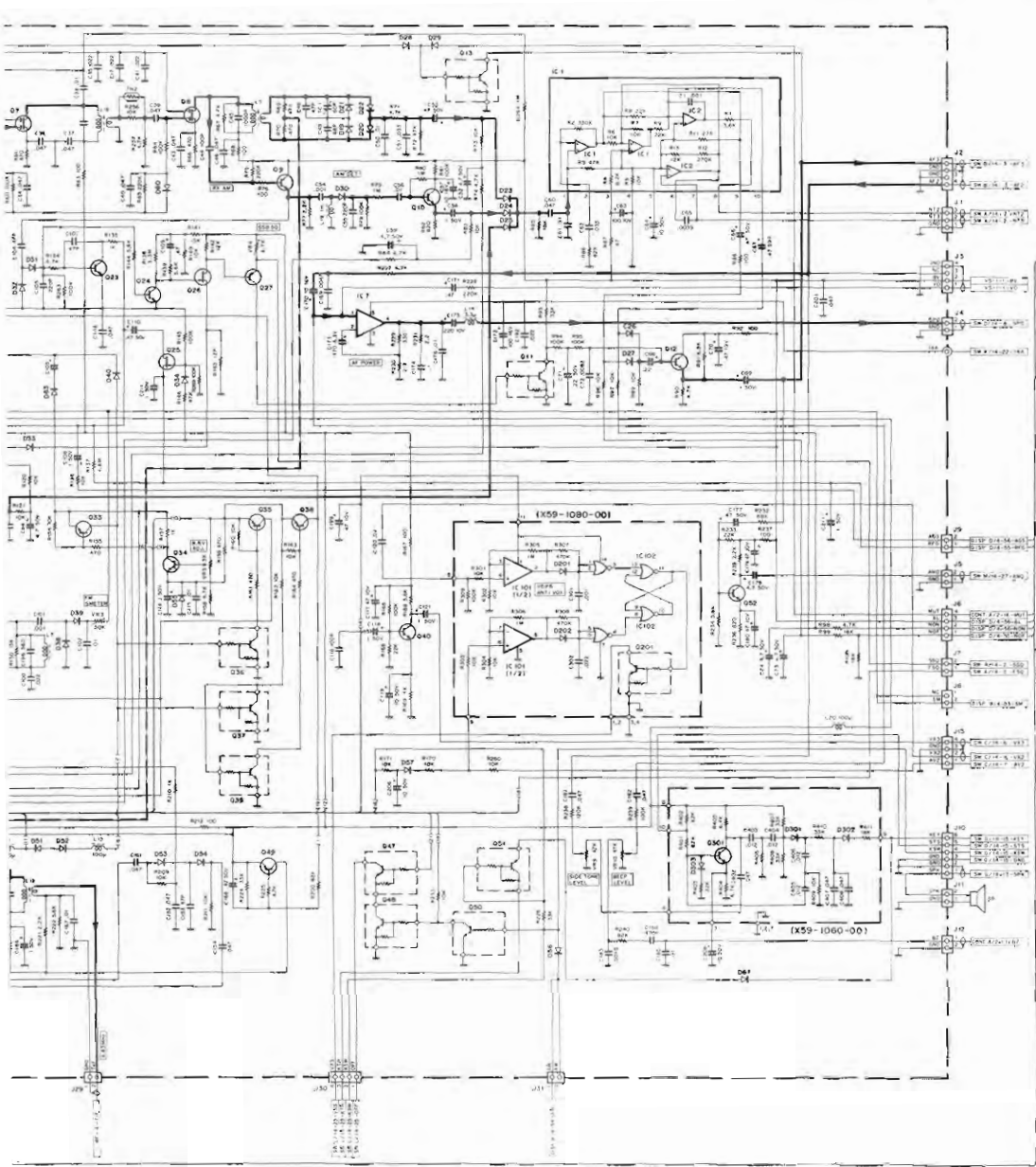

IC 1	887101
IC 2	M1351
IC 3	74LS123
IC 4	μPC1584H
IC 5	AN512
IC 7	μPC2009P
IC 8	74LS00
IC 10	884124
Q 1, 2, 3, 7, 8, 44	3547310R1
Q 3, 9, 17, 19, 23, 24, 34, 42, 45, 53, 54	2SC2456(1)
Q 54, 103, 103, 203, 34, 35, 39, 40, 55	DT11445
Q 10, 12, 16, 40, 44, 52	05C2456(1)
Q 14, 20, 32, 47, 48, 57	DT11435
Q 18, 21, 27, 48	2SA1086(1)
Q 20	2SA1825A1
Q 25, 26	2SK3040(1)
Q 33, 35, 38	2SA562(1)
Q 43	DT11445
D 1+4	1S1007
D 7, 8, 10, 12, 18, 36, 30, 53, 54	1S1687
D 2, 11, 23, 29, 31, 34, 41, 45, 46, 48, 49, 50, 52, 53, 74, 80, 88, 84	1S133
D 19, 22, 30, 35, 39, 42, 43	1N4001
Q 37, 38, 40, 45, 46, 49	1S1555
D 47	M204
D 51	M229, 108
D 52	V058
D 55	M252, 224
D 51	88C81
D 67	884801
D 67	1S1451
TA 1, 3	116-502-B
TA 4	32027
49-1040-00	25C2712(1)
Q 301	
D 301	
X59-1070-00	
Q 101-104	D111445
X59-1080-00	
IC 101	7429904M
IC 102	741001
Q 201	D11445

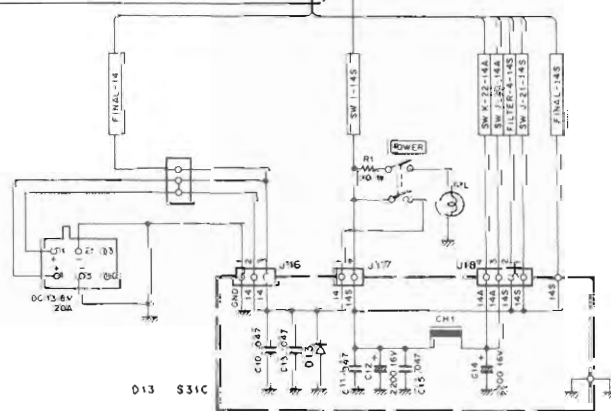
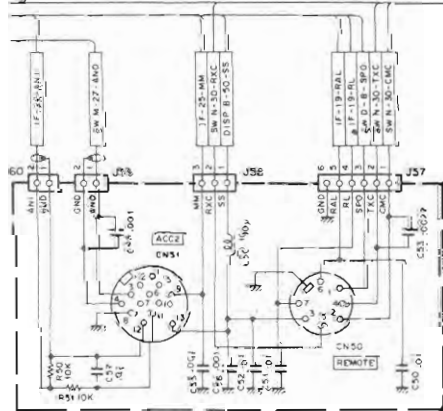
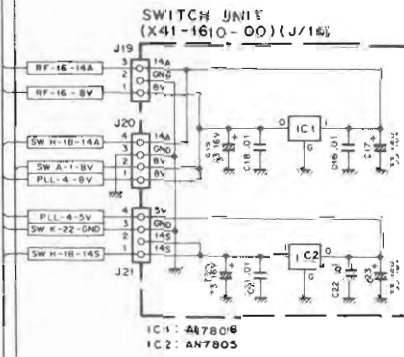
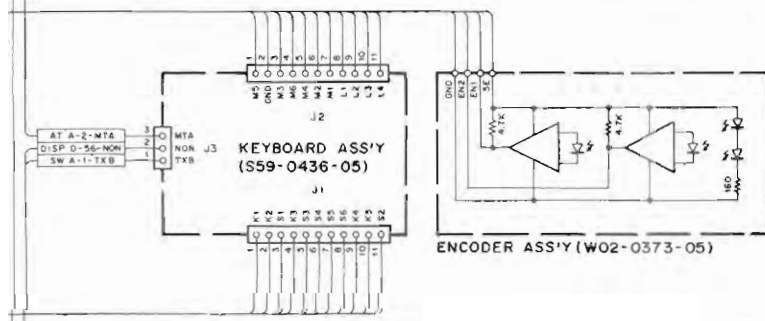
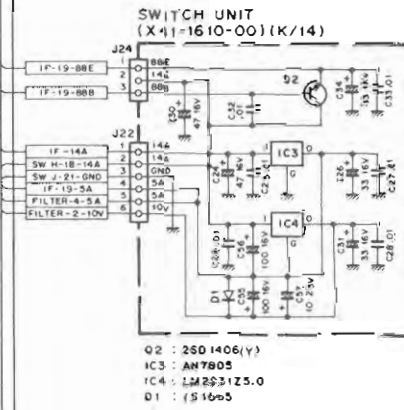
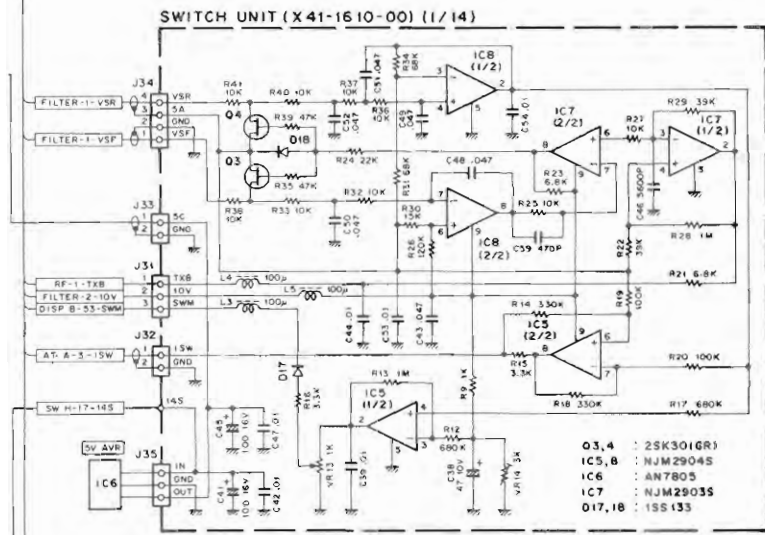
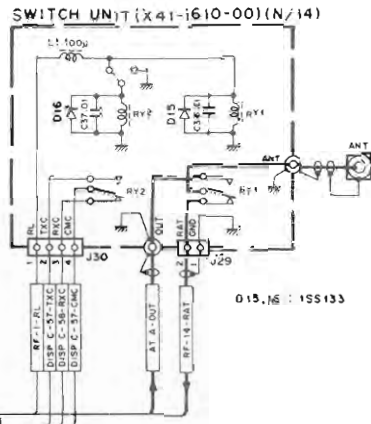
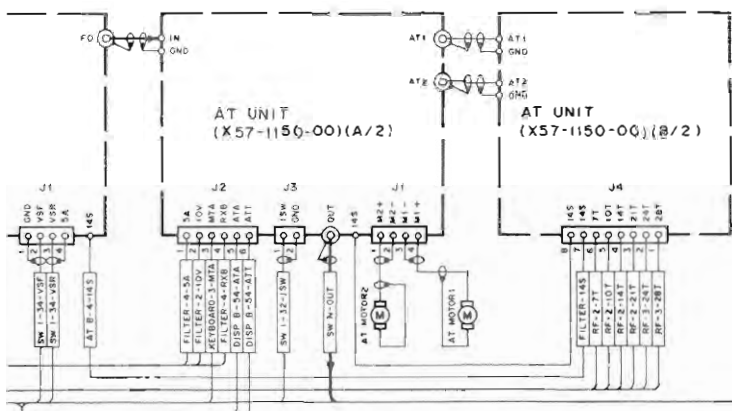

9. SPECIFICATIONS AND ACCESSORIES

9-1. SPECIFICATIONS

Specifications		Model	TS-440S	
General	Mode		LSB (A3J), USB (A3J), CW (A1), AM (A3), FM (F3), FSK (F1)	
	Antenna impedance	With AT unit	20 to 150 ohms (Transmit only)	
		Without AT unit	50 ohms	
	Power requirement		12 to 16 VDC (13.8 VDC reference)	
	Grounding		Negative	
	Current drain	Receive mode with no input signal	1.9 A	
		Transmit mode	20 A	
	Operating temperature		-10 to +50°C (+14 to +122°F)	
	Dimensions () includes projection.	Wide	270 (279) mm	
		High	96 (108) mm	
Deep		313 (335) mm		
Weight	With AT unit	7.3 kg (16.1 lbs)		
	Without AT unit	6.3 kg (13.9 lbs)		
Transmitter	Frequency range	160 m band	1.8 to 2.0 MHz	
		80 m band	3.5 to 4.0 MHz	
		40 m band	7.0 to 7.3 MHz	
		30 m band	10.1 to 10.15 MHz	
		20 m band	14.0 to 14.35 MHz	
		17 m band	18.068 to 18.168 MHz	
		15 m band	21.0 to 21.45 MHz	
		12 m band	24.89 to 24.99 MHz	
		10 m band	28.0 to 29.7 MHz	
	Input power	LSB, USB, CW, FM, FSK	200 W PEP	
		AM	110 W PEP	
	Modulation	LSB, USB	Balanced modulation	
		FM	Reactance modulation	
		AM	Low level modulation	
	Spurious radiation (CW)		Less than -40 dB	
	Carrier suppression		More than 40 dB (with 1.5 kHz reference)	
	Unwanted sideband suppression		More than 50 dB (with 1.5 kHz reference)	
	Third order distortion		More than 26 dB below one of two tones	
Maximum frequency deviation (FM)		± 5 kHz		
Frequency response (-6 dB)		400 to 2600 Hz		
Microphone impedance		500 ohms to 50 kΩ		
Receiver	Circuitry		Triple conversion superheterodyne	
	Frequency range		100 kHz to 30 MHz	
	Intermediate frequency		1st: 45.05 MHz, 2nd: 8.83 MHz, 3rd: 455 kHz	
	Sensitivity	LSB, USB, CW, FSK (at 10 dB S/N)	100 to 150 kHz	Less than 2.5 μV
			150 to 500 kHz	Less than 1 μV
			500 kHz to 1.6 MHz	Less than 4 μV
			1.6 to 30 MHz	Less than 0.25 μV
		AM (at 10 dB S/N)	100 to 150 kHz	Less than 25 μV
			150 to 500 kHz	Less than 13 μV
			500 kHz to 1.6 MHz	Less than 40 μV
1.6 to 30 MHz			Less than 2.5 μV	
FM (at 12 dB SINAD)		1.6 to 30 MHz	Less than 0.7 μV	

Specifications			Model	TS-440S
Receiver	Selectivity	LSB, USB, CW, FSK	-6 dB	2.2 kHz
			-60 dB	4.4 kHz
		AM	-6 dB	6 kHz
			-50 dB	18 kHz
		FM	-6 dB	12 kHz
			-50 dB	25 kHz
	Image ratio	100 kHz to 1.6 MHz		More than 50 dB
		1.6 to 30 MHz		More than 70 dB
	IF rejection	100 kHz to 1.6 MHz		More than 50 dB
		1.6 to 30 MHz		More than 70 dB
	IF SHIFT variable range			More than ± 0.9 kHz
	RIT/XIT variable range			More than ± 1 kHz
NOTCH filter attenuation			More than 20 dB (at 1.5 kHz)	
Squelch sensitivity	LSB, USB, CW, AM, FSK	100 to 150 kHz	Less than 20 μ V	
		150 to 500 kHz	Less than 10 μ V	
		500 kHz to 1.6 MHz	Less than 20 μ V	
		1.6 to 30 MHz	Less than 2 μ V	
	FM	1.6 to 30 MHz	Less than 0.32 μ V	
Output			1.5 W across 8 ohms load (10% distortion)	
Output load impedance			4 to 16 ohms (both ext. speaker and phones)	
Frequency control	Frequency accuracy (at RIT/XIT off)			Less than $\pm 1 \times 10^{-5}$
	Frequency stability (at RIT/XIT off)			Less than $\pm 1 \times 10^{-5}$ (-10 to + 50°C)

Circuit and ratings are subject to change without notice due to development in technology.

9-2. ACCESSORIES

Dynamic microphone (Except Europe and U.K.)	T91-0352-05	1 pc.
DC power cable assembly	E30-1638-05	1 pc.
Calibration cable	E31-2154-05	1 pc.
Fuse (20A)	F05-2034-05	1 pc.
Knob	K23-0712-04	1 pc.
DIN plug (7-pin)	E07-0751-05	1 pc.
Instruction manual	B50-8048-20	1 copy
Warranty card		1 copy

10. REFERENCE

10-1. Antenna installation

10-1-1. Fixed station

For HF fixed-station operation, an antenna specifically designed for amateur operation is recommended. Antenna types include wire antennas, verticals, rotary beams, and other antenna types. (Fig. 10-1) HF antennas are quite large and must be installed to withstand strong wind, heavy rain, etc.

Any antenna used with the TS-440S should be of 50-ohm impedance and should be connected using an appropriate coaxial cable such as RG-8/U.

Impedance matching is important. Impedance mismatching will result in a high VSWR and power loss, or can cause unwanted harmonic radiation and interference (TVI, BCI).

The impedance match can be checked with an SWR meter. Generally, satisfactory operation is assured when the VSWR (Voltage Standing Wave Ratio) is less than 1.5:1.

A rotary beam antenna is very effective for DX communication in the 14, 21 and 28 MHz bands. (Fig. 10-2) If open wire or balanced type transmission line is used with the antenna, a suitable antenna tuner with balun is recommended between the transceiver and the feed line. Methods of construction and operating such tuners are described in detail in the ARRL Antenna Handbook, or similar publications. For operation on the 160, 75 and 40 meter bands, a simple dipole antenna, cut to resonance in the most used portion of the band, will perform satisfactorily. For operation on the 10, 15 and 20 meter bands, the efficiency of the station will be greatly increased if a good directional rotary antenna is used. Remember that even the most sophisticated transceiver is useless without a good antenna.

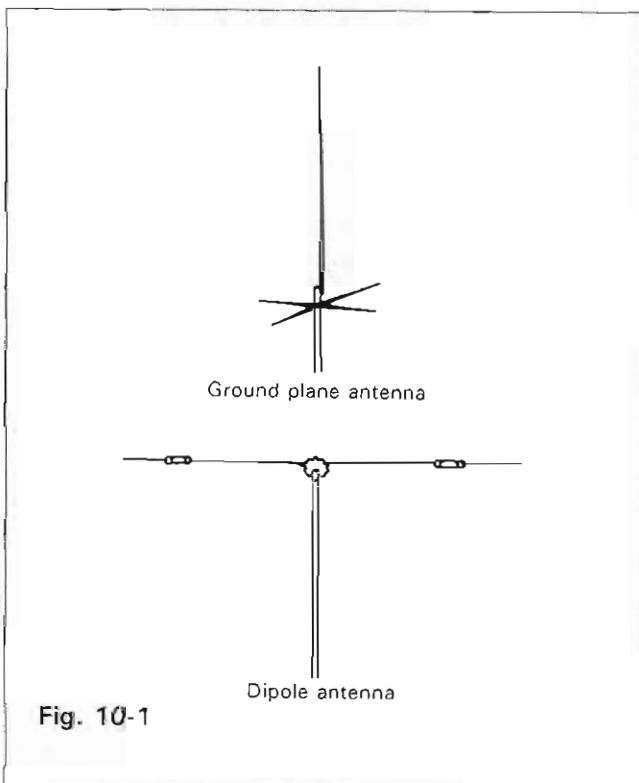

Fig. 10-1

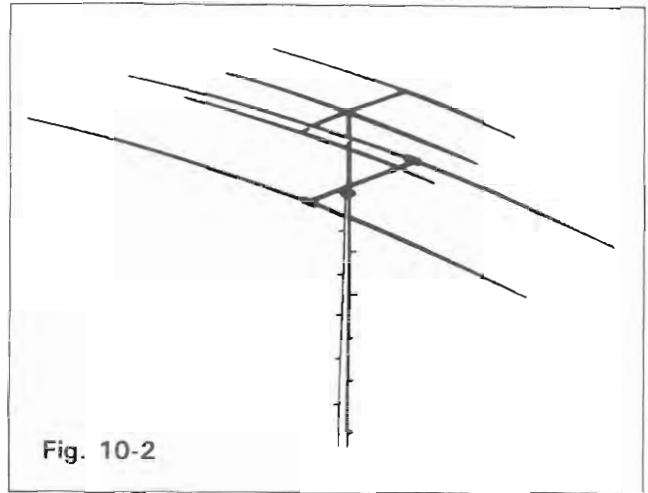

Fig. 10-2

10-1-2. Mobile

(1) Antenna

Use a sturdy mount for the mobile antenna since HF antennas are larger (and have more wind load) and are heavier than VHF antennas. A bumper mount is recommended for general use. The ground side of the mount must be well grounded to the car body, since the body itself functions as the ground plane for the mobile antenna. (Refer to Fig. 10-4)

Notes:

1. Some cars have plastic bumpers. For such cars, ground the antenna mount to the body.
2. When tuning a newly installed antenna, use the following procedure:
 - Turn the CAR control fully counter-clockwise for minimum transmit power.
 - With the transceiver in transmit mode, raise transmit power output slowly by rotating the CAR control clockwise. The antenna should be adjusted with minimum power.
 - Transmitting with full power is recommended only after the antenna has been adjusted for a VSWR below 1.5:1.
3. Antenna installation is critical for successful mobile operation. For further information refer to THE RADIO AMATEUR'S HANDBOOK, RADIO HANDBOOK, or other texts.

(2) Coaxial cable connection

When the antenna is mounted on the vehicle's bumper, the coaxial cable from the antenna can be routed through a drain hole in the trunk. When the antenna is roof mounted pass the cable between the body and door. Leave a driploop at the lowest point in the cable before entry into the vehicle to prevent water from entering the car.

(3) Adjustment

Some mobile antennas are not designed at 50-ohm impedance. In this case, impedance matching between the antenna and the coaxial cable (50Ω) is required. This can be achieved by using an antenna matching device or coupler.

The antenna to be used should first be checked with a dip meter to insure that it is designed for your operating band, then the impedance matching should be checked with an SWR meter. (Fig. 10-3)
 The VSWR should preferably be less than 1.5:1 for satisfactory operation. For antenna adjustment refer to the antenna instruction manual.

(4) Antenna matching

In general, mobile antennas have a lower impedance than the 50-ohm coaxial cable used to feed them, resulting in a mismatch between the antenna and the coax. Such trouble can be eliminated by using an antenna tuner between the transceiver and the coaxial cable.

o **Matching circuit examples**

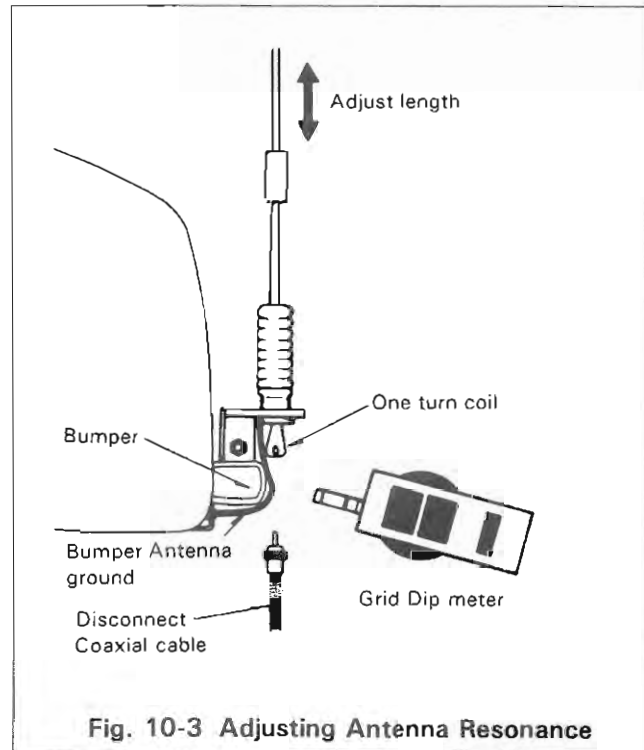
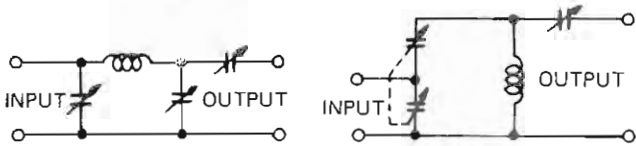

10-2. MOBIL OPERATION

10-2-1. Installation

Route battery and ANTENNA leads away from all high voltage secondary circuits to prevent ignition noise interference.

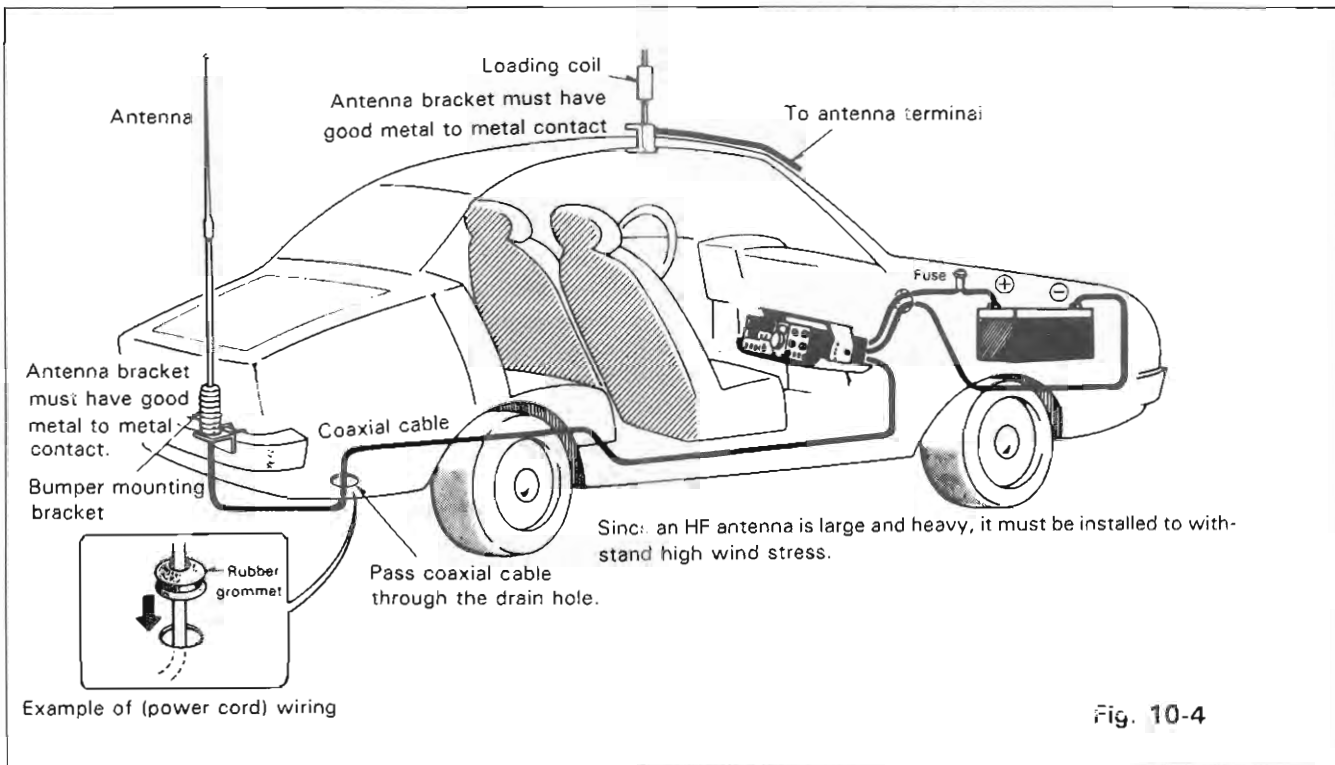

10-2-2. Noise reduction

In motor vehicles, noise is generated by the ignition system. Other sources of noise include the wiper and heater motors.

Although the transceiver is equipped with a noise blanker to minimize ignition noise, it is imperative that some preventive measures be taken to reduce the noise to the lowest possible level.

(1) Antenna location selection

Since ignition noise is generated by the vehicle's engine, the antenna must be installed as far from the engine as possible.

(2) Bonding

The component parts of motor vehicles, such as the engine, transmission, muffler system, accelerator, etc., are coupled to one another at DC and low frequencies, but are isolated at high frequencies. By connecting these parts using heavy, braided ground straps, ignition noise can be reduced. This connection is called "bonding".

(3) Use ignition suppressor cable or suppressor spark plugs

Noise can be reduced by using spark plugs with internal resistors, or resistive suppressor ignition cable.

10-2-3. Battery capacity

The power system of a motor vehicle is comprised of a battery and an alternator (which generates power while the engine is running) to supply current to loads or to charge the battery.

Since the transceiver draws high current during transmit, care should be exercised so the power system is not overloaded. When using the transceiver, the following points should be observed from the viewpoint of battery maintenance:

1. Turn the transceiver OFF when the lights, heater, wipers and other high-draw accessories are used.
2. Avoid transceiver operation when the engine is not running.
3. If necessary, use an ammeter and/or a voltmeter to check battery condition.

10-3. RADIO FREQUENCY ALLOCATION

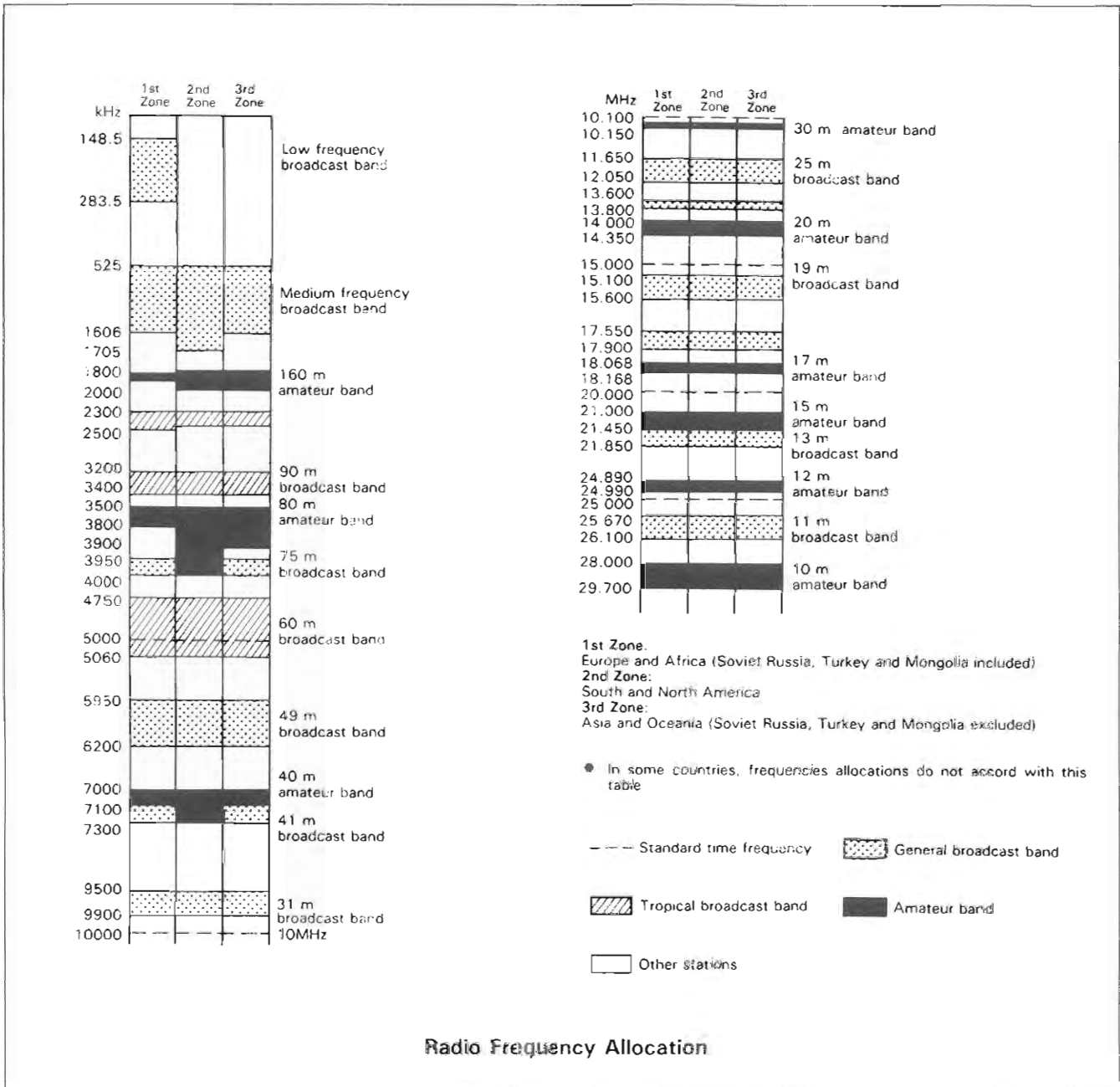

Frequency distribution in the broadcast and amateur bands

The general coverage receiver covers from 100 kHz to 30 MHz, to receive international broadcast and communication services.

As shown in the frequency allocation chart, above figure, broadcast and amateur radio station frequencies are allocated in specific bands expressed in megahertz (MHz) or wavelength in meters (m). Also in the above figure the frequencies of "other stations" are assigned for fixed station business use, marine mobile, aviation mobile, land mobile, radio beacon stations, etc.

Notes:

1. Radio stations throughout the world are listed in the **WORLD RADIO TV HANDBOOK** or similar publications.
2. Antennas designed for ham band operation will generally provide satisfactory reception for SW stations near the ham bands. For antenna construction details, see the **ARRL ANTENNA HANDBOOK**, or similar publications.

Model TS-440S

Serial No. _____

Date of Purchase _____

Dealer _____

KENWOOD